



MODULO

gruppi bar modulari
modular bar groups



- Corpo macchina in alluminio estruso e fianchi in ABS.
- Potenti motori con ventilazione forzata.
- Frullatore, frappé, rompighiaccio e spremiagrumi mantengono le caratteristiche tecniche e originali della macchina singola.

AL = spremiagrumi con leva
OQ = frullatore con bicchiere Quadro
N = rompighiaccio
S = frappé

- *Extruded aluminium machine body and sides in ABS.*
- *Powerful motor with forced ventilation.*
- *Blender, drink mixer, ice crusher and citrus juicer have the same technical and original features as the individual machines.*

AL = citrus juicers with lever
OQ = blender with square glass
N = ice crushers
S = drink mixers



MODULO 1 AL



MODULO 2 ALOQ



MODULO 2 ALN



MODULO 2 OQN



MODULO 3 ALOQN



MODULO 4 ALOQNS



Setaccio con 2 pigne
Sieve with 2 reamers









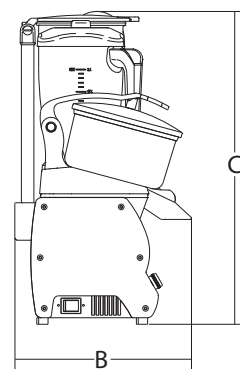
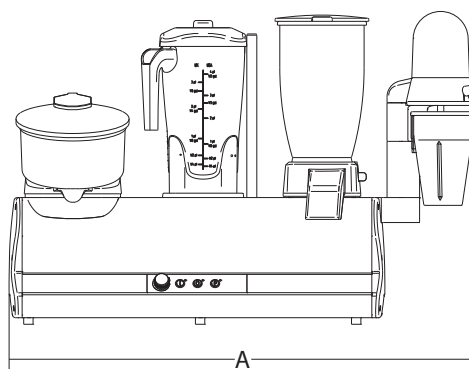

Bicchieri intercambiabili facilmente smontabili per la pulizia
Disassembled and interchangeable glasses, easy to cleaning



Bicchieri quadri impilabili
Stackable square glass



									
	watt	ph	r.p.m.	mm	mm	mm	kg	mm	kg
Modulo 1 AL	150	1ph	320	202	242	370	4.2	290x380x395	6
Modulo 2 ALOQ	150/750	1ph	320/8.000÷16.000	402	242	486	9.2	380x500x590	11
Modulo 2 ALN	150/150	1ph	320/800	402	283	495	9.5	380x500x590	11.5
Modulo 2 OQN	750/150	1ph	8.000÷16.000/800	402	283	495	10.2	380x500x590	12
Modulo 3 ALOQN	150/750/150	1ph	320/8.000÷16.000/800	602	283	495	13.7	380x705x590	16
Modulo 4 ALOQNS	150/750/150/100	1ph	320/8.000÷16.000/800/14.000	747	283	501	16.5	380x840x590	18.5