



## TRACKED EXCAVATOR | JS330/370 LC/NLC

Net engine power: 210kW (281hp) Bucket capacity: 0.86 - 1.93 m<sup>3</sup> Operating weight: 32972 - 38626 kg



# DURABILITY AND RELIABILITY.

BEFORE YOU BUY AN EXCAVATOR, YOU NEED TO KNOW IT'S GOING TO BE TOUGH ENOUGH TO PERFORM ANY JOB YOU ASK OF IT. FORTUNATELY, WITH A JCB JS330/370, STRENGTH AND DURABILITY COME AS STANDARD.



On the upper structure, there is a large storage space available to store chains and other essential accessories. We have added a new cover over the washer fluid bottle to maximise usable space.

## Boom and dipper.

1 A JCB JS330/370's reinforced boom and dipper is made of high tensile strength steel, with internal baffle plates for long life durability. In addition we fit heavy-duty wear strips at the dipper end for increased durability.

2 Our advanced manufacturing and assembly processes produce high precision and quality assembled components.

## Componentry.

3 JCB JS330/370s boast the best components in the industry, including a 6-cylinder, 210kW MTU engine, Berco running gear, Kawasaki pumps and Kayaba main control valves.

The MTU 6-cylinder 210kW engine uses a multi-stage fuel filtration system. This consists of a remote primary filter with built in water separator and secondary engine mounted filter. This system protects against a wide range of types of contaminants in fuel. A fuel shut off tap is fitted as standard along with a self priming lift pump for easy and simple servicing.

We use Finite Element Analysis with extensive rig and endurance testing to make key components last longer.



1



2



3



3



**Structural strength.**

- 4 The high-strength undercarriage of a JCB JS330/370 uses a fully-welded X frame construction for long-term durability even in the most demanding applications.
- 5 A closed box section revolving frame increases strength and reduces stress. It is also highly resistant to impact damage.
- 6 The JS330/370's high-strength rigid upper frame provides maximum durability and support.
- 7 Our stiff, durable door design gives great strength and rigidity.

The JCB JS330/370 turret is welded to both the upper and lower undercarriage frame.

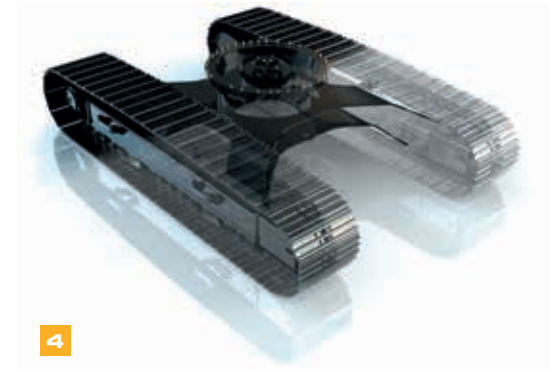

4

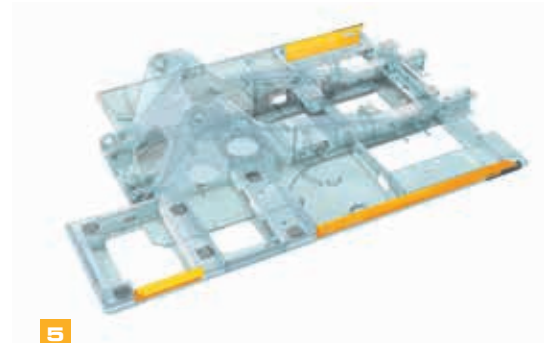

5

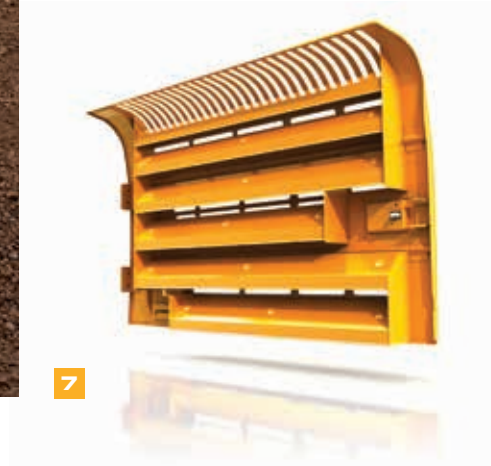

7



6

# MAXIMUM PRODUCTIVITY, MINIMUM SPEND.

IT'S MORE IMPORTANT THAN EVER TO SAVE MONEY AND TIME; THE JCB JS330/370 RANGE IS DESIGNED TO MAKE THE MOST OF BOTH.

## Efficiency.

Advanced hydraulic technology ensures that the machines always starts in idle for maximum fuel efficiency, contributing to fuel savings.

**1** The MTU 7.7-litre engine produces a formidable 210kW of power and 1150 Nm of torque, and works in harmony with the SMART control electronics to deliver smooth high torque power even at low RPM.



## Upping output.

**2** With up to a massive 231/266 kNm of bucket tearout and fast cycle times, the JS330/370 is extremely productive in all applications.

**3** Simultaneous tracking and excavating is smooth and fast with an intuitive multifunction operation.



An electric fan clutch automatically adjusts the fan speed based on the cooling demands. This reduces both noise and fuel consumption.





To save fuel, JCB Auto-Idle technology automatically reduces engine speed when hydraulics aren't in use.

**Stability, hydraulics and attachments.**

4 JCB's innovative hydraulic regeneration system means oil is recycled across the cylinders for faster cycle times and reduced fuel consumption.

5 A JCB JS330/370 has cushioned boom and dipper ends to prevent shock loadings, protect your machine and increase operator comfort.

JCB SMART Control gives access to variable working modes. The manually selectable High Plus mode offers great efficiency, with 5% gains over outgoing models.

For ultra versatility, JCB offers a full list of auxiliary pipework options including hammer, auxiliary, merged and low flow.



4



## A COMFORTABLE FAVOURITE.

JCB EXCAVATORS ARE DESIGNED AROUND THE OPERATOR. THAT'S GOOD FOR THEM BUT EVEN BETTER FOR YOU; AFTER ALL, GREAT COMFORT AND EASE OF USE EQUALS GREAT PRODUCTIVITY.

### Visibly better.

**1** A 70/30 front screen split gives JCB JS330/370s excellent front visibility. A clear view of the front right track provides easy, safe trench digging and manoeuvring.

**2** An innovative low-level bonnet provides excellent rearward visibility.

### Comfortably in control.

**3** The 7" colour multi-function display is easy to read in all light conditions, provides instant operational information, and has a customisable home screen.

JCB's new basic tool select system (fitted as standard) allows the operator to set up the single direction auxiliary and hammer circuit to match the flow requirements. The selected flow is achieved by automatically adjusting the engine rpm when the hydraulic service is operated.

You can easily check your JS330/370's DEF usage and level via the in-cab LCD monitor, which also warns you if you're running low.



A large laminated glass roof window gives the JS330/370 optimum visibility for working at height.

Light, intuitive and smooth controls improve comfort and productivity. The JS330/370's joystick-mounted power boost button gives extra hydraulic power fast.

A balanced slew and electronic/hydraulic controlled slew braking give speed and precision.



## The working environment.

**4** The JS330/370 creates a quieter working environment inside and out. Therefore, you can use the machine at any location, any time.

Our cabs use 6 viscous rubber mounts to minimise noise and vibration.

**5** JCB's climate control has been fully revised and is now standard, and offers a precisely controlled cab temperature with fresh or recirculated air. Demisting/defrosting functions keep the front window clear.

**6** There's a spacious luggage tray behind the operator's seat.

A large floor area with large high grip pedals and t-bar levers gives easy and precise tracking.

The Plus Pack is available as an option, and delivers a variety of enhancements to improve the operator experience.



The JS330/370's cab and controls are independently adjustable so that it's easy to find the perfect operating position.

We offer tailored seating options to suit many different applications.

# LESS SERVICING, MORE SERVICE.

WE'VE DESIGNED THE JCB JS330/370 TO BE LOW MAINTENANCE AND EASILY SERVICEABLE. WHICH MAKES THEM AFFORDABLE, EFFICIENT AND HIGHLY PRODUCTIVE. HELPING YOU GET THE BEST SERVICE FROM YOUR MACHINE.

Because worksites get dirty, we've equipped these excavators with a new and improved easy-to-clean-toolbox.

## Easy does it.

**1** The air filter on a JS330/370 is easily accessible, and a double-element construction simplifies cleaning. The latest Powercore air filter is fitted as standard, so cleaning intervals are longer than ever.

**2** The filters on a JCB JS330/370 (engine oil, hydraulic oil and fuel) are centrally located for fast, easy servicing. By reducing the number of fuel filters from three to two, we've cut the amount of routine maintenance you need to do on your excavator.

Unlike many Tier 4 Final excavators, JCB JS330s and JS370s don't require a diesel particulate filter (DPF). This eliminates the need for costly servicing or replacement of the filter. No filter also means no regeneration cycles, preventing any productivity constraints.

Filling your JS330/370 with DEF fluid is easily accessed via the upper structure. You can also access all main DEF components from there too.



By using graphite impregnated bronze bushes, we've reduced the JS330/370's boom and dipper greasing intervals to 1000 hours for normal applications.



1

	SERVICE INTERVALS
Engine oil and oil filter	Every <b>500</b> hours
Hydraulic oil	Every <b>5000</b> hours
Hydraulic oil filter	Every <b>1000</b> hours



(A) Hydraulics oil filters (B) Fuel filters





JCB JS330/370 grease points are centralised for safe and easy access to high level pivots.

The JCB JS330/370 bonnet opens and closes easily with gas-assisted cylinders, and the service bays are large and wide for good access.

**Here to help.**

- 3 JCB's Smart Control automatically checks the engine oil and engine coolant level on machine start up.
- 4 Because they're mounted side by side on a JCB JS330/370, the engine radiator, hydraulic cooler and intercooler can be serviced individually yet cleaned easily.
- 5 Service your JCB JS330/370 with your local main dealer and our trained engineers can minimise downtime. Order genuine JCB parts online and, in 95% of cases, they'll be with you next day. For extra security and machine protection, opt for a package like JCB LiveLink remote machine monitoring.



## THE SAFE CHOICE.

ON-SITE SAFETY IS CRUCIAL, SO WE'VE DESIGNED THE JS330/370 TO INCORPORATE AS MANY CUTTING EDGE SAFEGUARDS AS POSSIBLE. IN SHORT, YOUR OPERATORS ARE IN SAFE HANDS.



1 JCB JS330/370 bonnet opens front-to-rear for easy and safe engine service access. To make operator access safer, we've installed a tread plate over the engine of the new JS330 and 370. A fuel shut off tap provides a quick, safe way to change fuel filters and reduce the risk of spillage and contamination.



2 For extra peace of mind, JCB JS330/370 cabs are available with an optional external ROPS and FOPS protection.

3 JCB's Safety Lever Lock fully isolates hydraulic functions to avoid unintended movements. Our 2GO system means a JCB JS330/370 can only be started in a safe locked position via two separate inputs.

4 JCB JS330/370s have a large glass area and low bonnet line for superb visibility.

5 A JCB JS330/370's steps and platforms have anti-slip punched steel plates for optimum grip, even in wet or icy conditions. Bolt-on plates have recessed bolts to reduce trip hazard. We've also reconfigured the step arrangement so there's now a handy extra toolbox for secure storage.



We've fitted as standard a bulk head heat shield between the pumps and the engine to guard against heat and noise.



**6** JCB's standard rear view and optional side view cameras display uninterrupted rearward and sideward views on the smart controller display.

**7** Our JS330/370s come equipped with a full set of side and rear view mirrors as standard, providing all round visibility and safety compliance.

To reduce the risk of costly mistakes, we've made DEF and diesel tanks very distinct on the new JS330 and 370. They're coloured and named differently, opened by different keys, and have different-sized nozzles so you can't accidentally put diesel in the DEF tank.

Our factory-fit immobilisers can reduce your insurance premiums. Featuring automatic arming after a set time following engine shutdown.

JCB LiveLink telematics technology provides you with essential reports on everything from vehicle usage to fuel economy, idle time and engine load data.



# LIVELINK, WORK SMARTER.

**LIVELINK IS AN INNOVATIVE SOFTWARE SYSTEM THAT LETS YOU MANAGE JCB MACHINES REMOTELY – ONLINE, BY EMAIL OR BY MOBILE PHONE. ACCESS EVERYTHING FROM MACHINE ALERTS TO FUEL REPORTS AND HISTORY INFORMATION, WITH ALL DATA STORED AT A SECURE CENTRE.**

## Productivity and cost benefits

By providing information like idle time monitoring and machine fuel consumption, JCB Livelink helps reduce your fuel usage, saving money and improving productivity. Machine location information can help improve efficiency and perhaps even reduce insurance costs.

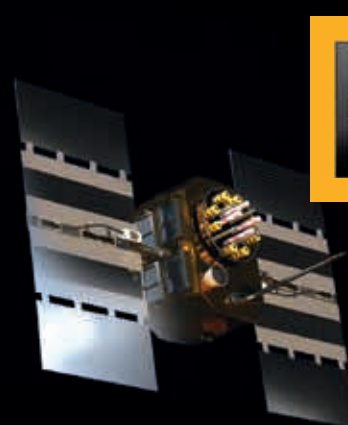

## Maintenance benefits

Manage machine maintenance easily – accurate hours monitoring and service alerts improve maintenance planning, while real-time location data helps you manage your fleet. Critical machine alerts and maintenance history records are also available.



## Security benefits

Livelink's real-time geofencing alerts tell you when machines move out of predetermined zones, and real-time curfew alerts inform you of unauthorised usage. Further benefits include real-time location information, advanced ECU matching (pairs Livelink with the immobiliser or ECU).



## VALUE ADDED.

JCB'S WORLDWIDE CUSTOMER SUPPORT IS FIRST CLASS. WHATEVER YOU NEED AND WHEREVER YOU ARE, WE'LL BE AVAILABLE QUICKLY AND EFFICIENTLY TO HELP MAKE SURE YOUR MACHINERY IS PERFORMING TO ITS FULL POTENTIAL.



1

1 Our Technical Support Service provides instant access to factory expertise, day or night, while our Finance and Insurance teams are always on hand to provide fast, flexible, competitive quotes.

2 The global network of JCB Parts Centres is another model of efficiency; with 16 regional bases, we can deliver around 95% of all parts anywhere in the world within 24 hours. Our genuine JCB parts are designed to work in perfect harmony with your machine for optimum performance and productivity.



2

3 JCB Assetcare offers comprehensive extended warranties and service agreements, as well as service-only or repair and maintenance contracts. Irrespective of what you opt for, our maintenance teams around the world charge competitive labour rates, and offer non-obligation quotations as well as fast, efficient insurance repair work.



3

Note: JCB LIVELINK and JCB ASSETCARE may not be available in your region, so please check with your local dealer.

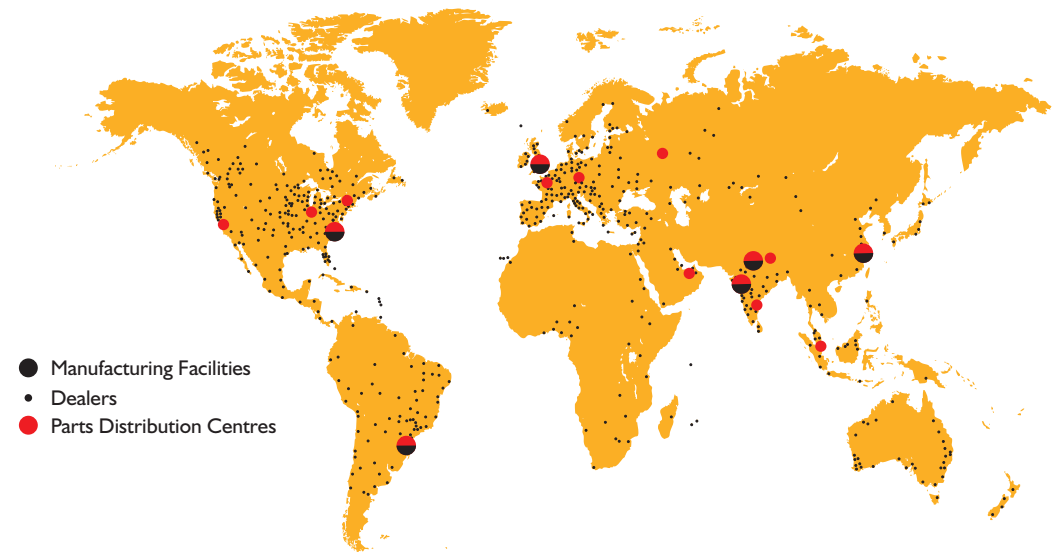

- Manufacturing Facilities
- Dealers
- Parts Distribution Centres

STATIC DIMENSIONS

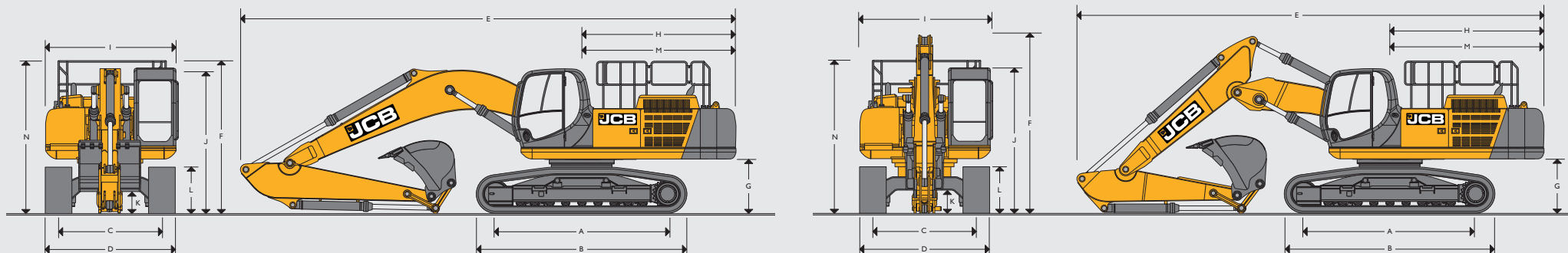

STATIC DIMENSIONS

Model		JS330 LC	JS330 NLC	JS370 LC	JS370 NLC				
A	Track length on ground	3965	3965	4022	4022				
B	Undercarriage overall length	4848	4848	4954	4954				
C	Track gauge	2600	2390	2600	2390				
D	Width over tracks (600mm trackshoes)	3200	2990	3200	2990				
D	Width over tracks (700mm trackshoes)	3300	3090	3300	3090				
D	Width over tracks (800mm trackshoes)	3400	3190	3400	3190				
D	Width over tracks (900mm trackshoes)	3500	3290	3500	3290				
G	Counterweight clearance	1195	1195	1215	1215				
H	Tail swing radius	3571	3571	3571	3571				
I	Overall width of superstructure	2990	2990	2990	2990				
J	Height over cab	3177	3177	3202	3202				
K	Ground clearance	506	506	530	530				
L	Track height	1011	1011	1024	1024				
M	Tail length	3563	3563	3563	3563				
N	Height over grab rail	3335	3335	3360	3360				
		<b>Monoboom 6.45m</b>				<b>Monoboom 6.45m</b>			
<b>Dipper lengths</b>		<b>2.21m</b>	<b>2.63m</b>	<b>3.23m</b>	<b>4.03m</b>	<b>2.21m</b>	<b>2.63m</b>	<b>3.23m</b>	<b>4.03m</b>
E	Transport length	11382	11291	11257	11279	11448	11321	11248	11329
F	Transport height	3625	3591	3767	3887	3562	3360	3360	3698
		<b>ME boom 6.10m</b>				<b>ME boom 6.10m</b>			
<b>Dipper lengths</b>		<b>2.21m</b>		<b>2.63m</b>		<b>2.21m</b>		<b>2.63m</b>	
E	Transport length	11039		10946		11081		11008	
F	Transport height	3662		3759		3720		3813	
		<b>T.A.B. 6.45m</b>				<b>T.A.B. 6.45m</b>			
<b>Dipper lengths</b>		<b>2.21m</b>	<b>2.63m</b>	<b>3.23m</b>	<b>4.03m</b>	<b>2.21m</b>	<b>2.63m</b>	<b>3.23m</b>	<b>4.03m</b>
E	Transport length	10755	10765	10764	10864	10877	10734	10978	10938
F	Transport height	3885	3870	3897	3845	3921	4041	3690	3879

ENGINE	
Model	MTU 6R1000 Tier 4 Final compliant
Type	Water cooled, 4-stroke, 6-cylinder in-line, common rail direct injection, turbocharged intercooled diesel.
Rated power (net)	210kW (281 hp) at 1900rpm.
Piston Displacement	7.7 litres
Air Filtration	Dry element with secondary safety element and in-cab warning indicator.
Starting system	24 volt.
Batteries	2 x 12 volt.
Alternator	24 volt, 100 ampere.

SLEW SYSTEM	
Slew motor	Axial piston type.
Slew brake	Hydraulic braking plus automatic spring applied disc type parking brake.
Slew torque	<b>JS330:</b> 111 kNm <b>JS370:</b> 129 kNm
Slew speed	<b>JS330:</b> 8.5rpm <b>JS370:</b> 8.9rpm
Slew gear	Large diameter, internally toothed fully sealed grease bath lubricated.

UNDERCARRIAGE	
Carriage options	LC - Long Carriage and NLC - Narrow Long Carriage.
Construction	Fully welded, 'X' frame type with central bellyguarding and sloping sidemembers with dirt relief holes under top rollers.
Recovery point	Front and rear.
Track shoe options	600mm, 700mm, 800mm, 900mm.
Upper and lower rollers	Heat treated, sealed and lubricated.
Track adjustment	Grease cylinder type.
Track idler	Sealed and lubricated, with spring cushioned recoil.
Track type	Sealed and lubricated.
No. of track guides	2 per side
No. of lower rollers (each side)	9 per side
No. of upper rollers (each side)	2 per side
No. of track shoes	JS330: 50 JS370: 48

TRACK DRIVE	
Type	Fully hydrostatic, two speed with autoshift.
Travel motors	Variable swash axial piston type, fully guarded within undercarriage frame.
Final drive	Planetary reduction, bolt-on sprockets.
Service brake	Hydraulic counter balance valve.
Park brake	Disc type, spring applied, automatic hydraulic release.
Gradeability	70% (35 deg) continuous.
Travel speed	<b>JS330</b> <b>JS370</b>
	High – 5.2km/h High – 5.2 km/h
	Low – 3.0 km/h Low – 3.0km/h
Tractive effort	256 kN 250 kN

HYDRAULIC SYSTEM	
A variable flow negative control system with flow on demand, variable power output and servo operated, multi function open centre.	
<b>Pumps</b>	
Main pumps	2 variable displacement axial piston type.
Maximum flow	<b>JS330:</b> 2 x 291 l/min <b>JS370:</b> 2 x 304 l/min
Servo pump	Gear type.
Maximum flow	28.5 l/min
<b>Control valve</b>	
A combined four and five spool control valve with auxiliary service spool as standard.	
<b>Relief valve settings</b>	
Boom/Arm/Bucket	319 bar
With power boost	348 bar
Swing circuit	JS300: 250 bar JS370: 290 bar
Travel circuit	348 bar
Pilot control	44 bar
<b>Filtration</b>	
In tank	150 micron, suction strainer.
Main return line	10 micron, glass fibre element.
Pilot line	10 micron, paper element.
Hydraulic hammer return	10 micron, reinforced microform element.

SERVICE CAPACITIES		
Fuel tank	Litres	590
Engine coolant	Litres	39
Engine oil	Litres	25
Swing reduction gear	Litres	16
Track reduction gear (each side)	Litres	5
Hydraulic system	Litres	430
Hydraulic tank	Litres	239
DEF fluid	Litres	47

## STANDARD EXCAVATING BUCKETS – JS330

Bucket options		GP Bucket				HD Bucket			
Bucket width	mm	950	1400	1550	1800	950	1400	1550	1800
Bucket capacity	m <sup>3</sup>	0.86	1.43	1.62	1.93	0.86	1.43	1.62	1.93
Bucket weight	kg	834	1058	1145	1277	925	1189	1268	1428
<b>Monoboom 6.45m</b>									
2.21m		☐	☐	☐	☐	☐	☐	☐	☐
2.63m		☐	☐	☐	☐	☐	☐	☐	☐
3.23m		☐	☐	☐	●	☐	☐	☐	●
4.03m		☐	☐	●	■	☐	☐	●	■
<b>ME Boom 6.10m</b>									
2.21m		☐	☐	☐	☐	☐	☐	☐	☐
2.63m		☐	☐	☐	☐	☐	☐	☐	☐
<b>T.A.B. 6.45m</b>									
2.21m		☐	☐	☐	☐	☐	☐	☐	☐
2.63m		☐	☐	☐	☐	☐	☐	☐	☐
3.23m		☐	☐	☐	●	☐	☐	☐	●
4.03m		☐	☐	●	■	☐	●	●	■

☐ = Material weight up to 2000kg/m<sup>3</sup>.● = Material weight up to 1600kg/m<sup>3</sup>.■ = Material weight up to 1200kg/m<sup>3</sup>.

These recommendations are based on an LC undercarriage fitted with 600mm tracks and JCB quick hitch.

They are a guide only, please contact your distributor for more information on selecting the correct attachment to suit your application(s).

## WEIGHTS AND GROUND BEARING PRESSURES – JS330

Machine specified with a 3.23m dipper, 1.8m<sup>3</sup> Bucket, operator and full fuel tank

		600mm shoes	700mm shoes	800mm shoes	900mm shoes
<b>JS330 LC Monoboom</b>					
Machine weight	kg	33364	33764	34164	34564
Ground bearing pressure	kg/cm <sup>2</sup>	0.66	0.57	0.51	0.45
<b>JS330 NLC Monoboom</b>					
Machine weight	kg	33224	33624	34024	34424
Ground bearing pressure	kg/cm <sup>2</sup>	0.66	0.57	0.50	0.45
<b>JS330 LC ME Boom</b>					
Machine weight	kg	33112	33512	33912	34312
Ground bearing pressure	kg/cm <sup>2</sup>	0.65	0.57	0.50	0.45
<b>JS330 NLC ME Boom</b>					
Machine weight	kg	32972	33372	33772	34172
Ground bearing pressure	kg/cm <sup>2</sup>	0.65	0.56	0.50	0.45
<b>JS330 LC T.A.B.</b>					
Machine weight	kg	35088	35488	35888	36288
Ground bearing pressure	kg/cm <sup>2</sup>	0.70	0.60	0.53	0.48
<b>JS330 NLC T.A.B.</b>					
Machine weight	kg	34948	35348	35748	36148
Ground bearing pressure	kg/cm <sup>2</sup>	0.69	0.60	0.53	0.48

## STANDARD EXCAVATING BUCKETS – JS370

Bucket options		GP Bucket				HD Bucket			
Bucket width	mm	950	1400	1550	1800	950	1400	1550	1800
Bucket capacity	m <sup>3</sup>	0.86	1.43	1.62	1.93	0.86	1.43	1.62	1.93
Bucket weight	kg	834	1058	1145	1277	925	1189	1268	1428
<b>Monoboom 6.45m</b>									
2.21m		☐	☐	☐	☐	☐	☐	☐	☐
2.63m		☐	☐	☐	☐	☐	☐	☐	☐
3.23m		☐	☐	☐	☐	☐	☐	☐	☐
4.03m		☐	☐	☐	●	☐	☐	☐	●
<b>ME Boom 6.10m</b>									
2.21m		☐	☐	☐	☐	☐	☐	☐	☐
2.63m		☐	☐	☐	☐	☐	☐	☐	☐
<b>T.A.B. 6.45m</b>									
2.21m		☐	☐	☐	☐	☐	☐	☐	☐
2.63m		☐	☐	☐	☐	☐	☐	☐	☐
3.23m		☐	☐	☐	☐	☐	☐	☐	☐
4.03m		☐	☐	☐	●	☐	☐	☐	●

☐ = Material weight up to 2000kg/m<sup>3</sup>.● = Material weight up to 1600kg/m<sup>3</sup>.■ = Material weight up to 1200kg/m<sup>3</sup>.

These recommendations are based on an LC undercarriage fitted with 600mm tracks and JCB quick hitch.

They are a guide only, please contact your distributor for more information on selecting the correct attachment to suit your application(s).

## WEIGHTS AND GROUND BEARING PRESSURES – JS370

Machine specified with a 3.23m dipper, 1.8m<sup>3</sup> Bucket, operator and full fuel tank

		600mm shoes	700mm shoes	800mm shoes	900mm shoes
<b>JS370 LC Monoboom</b>					
Machine weight	kg	36301	36746	37191	37636
Ground bearing pressure	kg/cm <sup>2</sup>	0.70	0.60	0.53	0.48
<b>JS370 NLC Monoboom</b>					
Machine weight	kg	36142	36587	37032	37477
Ground bearing pressure	kg/cm <sup>2</sup>	0.69	0.60	0.53	0.48
<b>JS370 LC ME Boom</b>					
Machine weight	kg	36207	36652	37097	37542
Ground bearing pressure	kg/cm <sup>2</sup>	0.69	0.60	0.53	0.48
<b>JS370 NLC ME Boom</b>					
Machine weight	kg	36048	36493	36938	37383
Ground bearing pressure	kg/cm <sup>2</sup>	0.69	0.60	0.53	0.48
<b>JS370 LC T.A.B.</b>					
Machine weight	kg	37291	37736	38181	38626
Ground bearing pressure	kg/cm <sup>2</sup>	0.72	0.62	0.55	0.49
<b>JS370 NLC T.A.B.</b>					
Machine weight	kg	37132	37577	38022	38467
Ground bearing pressure	kg/cm <sup>2</sup>	0.71	0.62	0.55	0.49



**JS330 WORKING RANGE – MONOBOOM 6.45M**

Dipper length:		2.21m	2.63m	3.23m	4.03m	
A	Maximum digging reach	mm	10083	10492	11036	11777
B	Maximum digging reach (on ground)	mm	9876	10288	10843	11596
C	Maximum digging depth	mm	6278	6705	7290	8101
D	Maximum digging height	mm	9626	9857	10153	10457
E	Maximum dumping height	mm	6797	7003	7279	7557
F	Maximum vertical wall cut depth	mm	4928	5517	6706	7027
G	Minimum swing radius	mm	4673	4638	4057	4521
	Bucket rotation	degrees	185	185	185	185
	Maximum dipper tearout	kNm	207.4	181.1	150.5	130.4
	Maximum bucket tearout	kNm	231.0	231.0	231.0	231.0

**JS330 WORKING RANGE – T.A.B. 6.45M**

Dipper length:		2.21m	2.63m	3.23m	4.03m	
A	Maximum digging reach	mm	10181	10599	11181	11922
B	Maximum digging reach (on ground)	mm	9973	10399	10991	11744
C	Maximum digging depth	mm	5812	6240	6837	7618
D	Maximum digging height	mm	11530	11893	12389	12968
E	Maximum dumping height	mm	8419	8772	9263	9841
F	Maximum vertical wall cut depth	mm	4552	5036	5681	6616
G	Minimum swing radius	mm	3022	3086	2909	3311
	Bucket rotation	degrees	185	185	185	185
	Maximum dipper tearout	kNm	207.4	181.1	150.5	130.4
	Maximum bucket tearout	kNm	231.0	231.0	231.0	231.0

**JS330 WORKING RANGE – ME BOOM 6.10M**

Dipper length:		2.21m	2.63m	
A	Maximum digging reach	mm	9778	10184
B	Maximum digging reach (on ground)	mm	9558	9978
C	Maximum digging depth	mm	5923	6375
D	Maximum digging height	mm	9573	9816
E	Maximum dumping height	mm	6695	6911
F	Maximum vertical wall cut depth	mm	4895	5488
G	Minimum swing radius	mm	4298	4327
	Bucket rotation	degrees	185	185
	Maximum dipper tearout	kNm	207.4	181.1
	Maximum bucket tearout	kNm	231.0	231.0

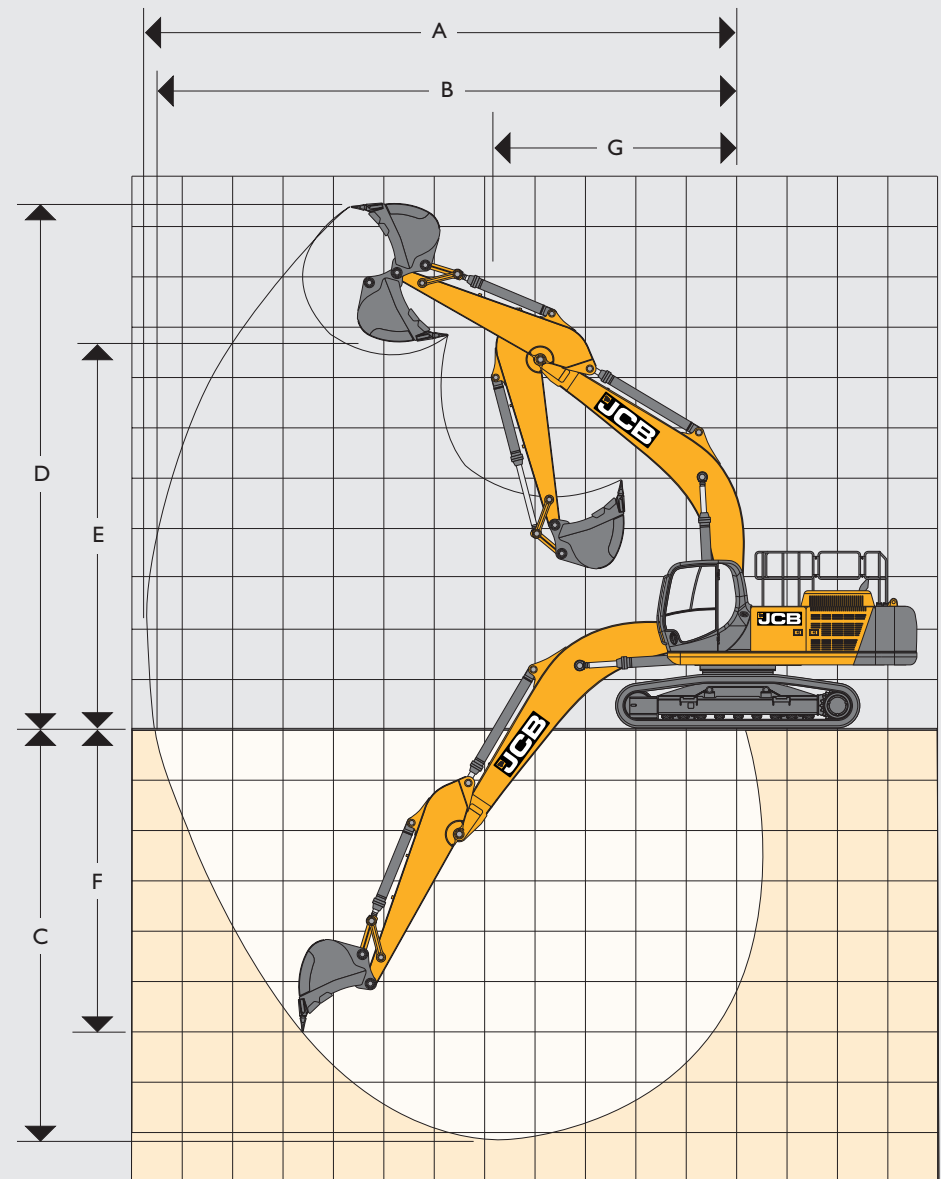

**JS370 WORKING RANGE – MONOBOOM 6.45M**

Dipper length:		2.21m	2.63m	3.23m	4.03m	
A	Maximum digging reach	mm	10079	10485	11023	11770
B	Maximum digging reach (on ground)	mm	9863	10269	10826	11586
C	Maximum digging depth	mm	6260	6690	7288	8084
D	Maximum digging height	mm	9584	9808	10094	10414
E	Maximum dumping height	mm	6789	6983	7245	7555
F	Maximum vertical wall cut depth	mm	4747	5325	6041	6880
G	Minimum swing radius	mm	4738	4714	4571	4608
	Bucket rotation	degrees	185	185	185	185
	Maximum dipper tearout	kNm	245.8	214.8	178.4	153.3
	Maximum bucket tearout	kNm	265.8	265.8	265.8	265.8

**JS370 WORKING RANGE – T.A.B. 6.45M**

Dipper length:		2.21m	2.63m	3.23m	4.03m	
A	Maximum digging reach	mm	10177	10570	11136	11935
B	Maximum digging reach (on ground)	mm	9963	10364	10942	11754
C	Maximum digging depth	mm	5784	6211	6808	7595
D	Maximum digging height	mm	11581	11909	12266	13035
E	Maximum dumping height	mm	8451	8823	9162	9904
F	Maximum vertical wall cut depth	mm	4535	5017	5665	6463
G	Minimum swing radius	mm	3073	3165	2994	3353
	Bucket rotation	degrees	185	185	185	185
	Maximum dipper tearout	kNm	245.8	214.8	178.4	153.3
	Maximum bucket tearout	kNm	265.8	265.8	265.8	265.8

**JS370 WORKING RANGE – ME BOOM 6.10M**

Dipper length:		2.21m	2.63m	
A	Maximum digging reach	mm	9761	10168
B	Maximum digging reach (on ground)	mm	9388	9954
C	Maximum digging depth	mm	5932	6360
D	Maximum digging height	mm	7459	9752
E	Maximum dumping height	mm	4924	6878
F	Maximum vertical wall cut depth	mm	4704	5284
G	Minimum swing radius	mm	5939	4396
	Bucket rotation	degrees	185	185
	Maximum dipper tearout	kNm	245.8	214.8
	Maximum bucket tearout	kNm	265.8	265.8

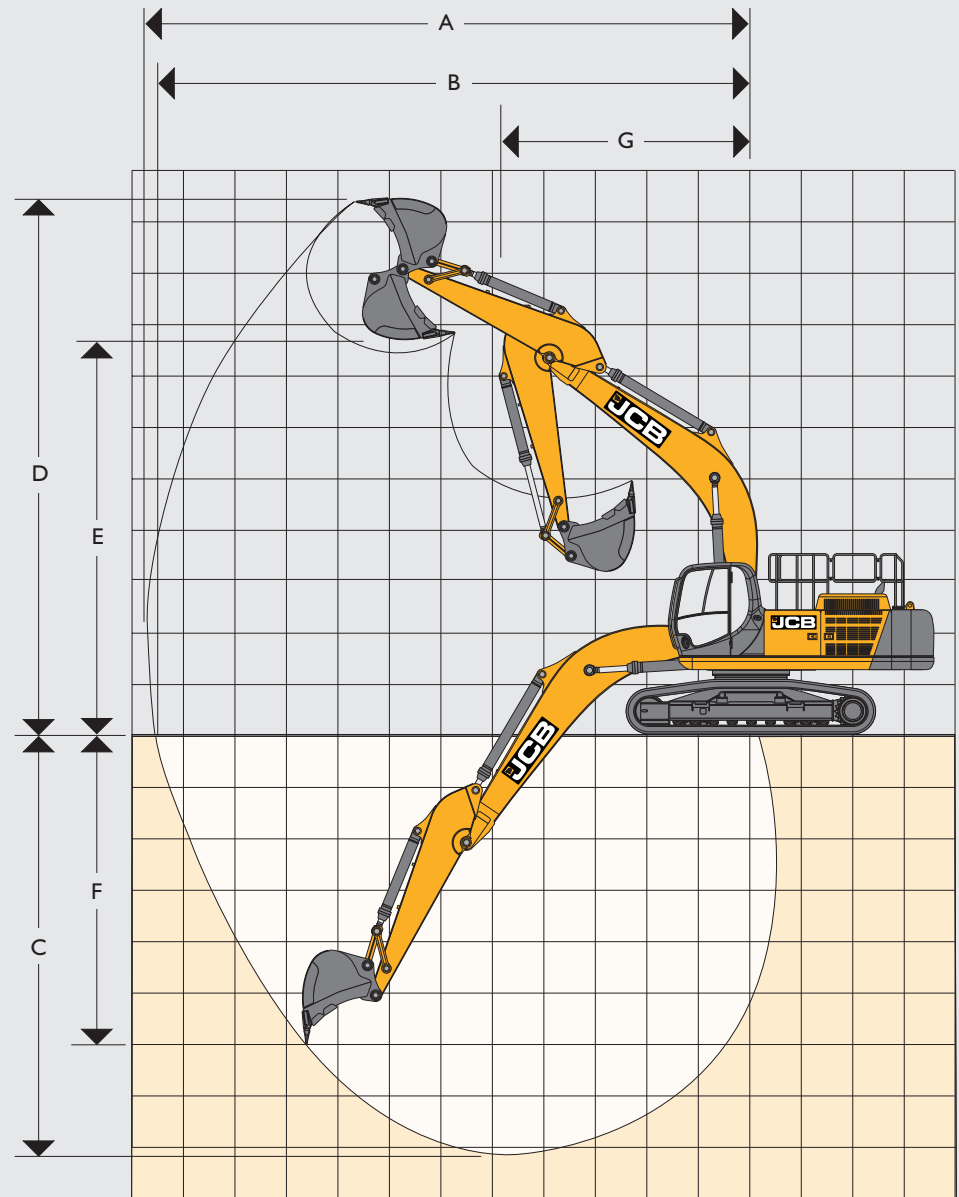

**STANDARD/OPTIONAL EQUIPMENT**

<b>ENGINE</b>	
MTU, Stage IV compliant, SCR, EGR, DOC, water-cooled diesel engine with Fixed Turbo Charger and air-to-air intercooler	•
Start pre-heat	•
DEF Tank	•
One touch idle	•
Auto-idle function	•
No DPF	•
Refuelling pump	•
Fan guard	•
Heavy duty batteries	•
Fuel filter with water seperator	•
Fuel shutoff tap	•
Electronic engine control	•
Fuel Cooler	•
Scavenge air filter	+
<b>SAFETY</b>	
Side guard rails on upper structure and steps	•
Rear-view camera	•
Battery isolator	•
Key	•
2 GO	•
Lockable fuel cap	•
Work lights (1 main frame, 2 boom mounted, 1 counterweight)	•
Additional work lights (2 cab mounted)	+
LED worklight upgrade	+
FOPS II guards – top and front	+
Demolition cage (FOPS level II)	XD only
Side-view camera	+
Travel alarm	+
White noise travel alarm	+
Green beacon linked seat belt	+
Fire extinguiser	+
Vandal guards	+
Chevron counterweight	+
Roll Over Protective Structure (ROPS)	+
Boom and arm cylinder safety valves & overload warning	+
Rear counterweight safety handrails	+
Rotating beacon	+
2 x counterweight beacons	+













<b>CAB &amp; INTERIOR</b>	
Sound-insulated and 6 shock mounted cab	•
Mechanical suspension seat	•
Air conditioning with climate control	•
Opening front window and removable lower front window	•
Sliding left window	•
Upper windscreen wiper	•
3 button joysticks	•
Travel pedals and T hand levers	•
Immobiliser	•
Loudspeakers and connections for radio	•
Standard cab filtration	•
Electric horn	•
Interior cab light	•
12V power socket	•
7" colour monitor	•
Retractable 2" seat belt	•
3" seat belt	+
Full length front blind	+
Half length front blind	+
Heated, adjustable air suspension seat with adjustable headrest and armrest	+
Lower windscreen wiper	+
Radio	+
Carbon air filter	+
Deluxe seat	+
Rain visor	+
<b>UNDERCARRIAGE</b>	
600, 700, 800, 900 mm triple grouser shoe	+
Narrow undercarriage	+
Greased and sealed track links	•
Twin track guards	•
Full length track guards (JS370 only)	XD only
<b>DIG END</b>	
No lift tipping link	•
Dippers: 2210 mm, 2630 mm, 3230 mm, 4030 mm	+
XD Dipper: 2210 mm, 2630 mm	XD only
Lifting hook t/link	+
Lifting shackle t/link	+
Bucket ram guards	+
Triple Articulating Boom (TAB)	+
Mass Excavation boom (ME)	+
Long reach rig: 12330 mm boom, 9500 mm dipper	+

<b>HYDRAULIC SYSTEM</b>	
Boom and arm flow regeneration	•
One-touch power boost function	•
Boom/slew priority control	•
Cushion control	•
Cylinder cushioning and contamination seals	•
Oil cooler	•
Control of auxiliary hydraulic flow and pressure from display panel with I/O tool setting storage	+
High and low flow aux options	+
Bio oil	+
Panolin oil	+
Quick hitch pipework	+
Hydraulic hitch	+
ISO/SAE changeover	+
Quick release couplings	+
Hose burst check valves	+
Breaker piping	+
Shut off taps	+















<b>OTHER</b>	
Livelink telematics	•
10mm Heavy-duty upper and lower belly plates	+
Side impact protection	+
Fly screens	+
Tracked tool kit	+
Guards for work lights	+

**STANDARD** •  
**OPTIONAL** +















**LIFT CAPACITIES – Dipper length: 2.21m, Boom: 6.45m, Trackshoes: 600mm triple grouser. JS330 LC MONO**

Load Point	Reach from Swing Centre															
	1.5m		3m		4.5m		6m		7.5m		9m		Max Reach			
																
Height	kg	kg	kg	kg	kg	kg	kg	kg	kg	kg	kg	kg	kg	kg	kg	mm
7.5m							8640*	8640*					8580*	8100	6491	
6m							8960*	8960*	8240*	6310			8240*	6270	7523	
4.5m					12990*	12990*	9900*	8640	8470*	6170			7970	5390	8151	
3m							11000*	8150	8880	5940			7370	4950	8467	
1.5m							11760*	7770	8650	5730			7200	4810	8506	
0m					15700*	11470	11840	7580	8520	5610			7420	4930	8273	
- 1.5m					14560*	11530	11340*	7550	8520	5610			8160	5390	7741	
- 3m			14810*	14810*	12550*	11730	9820	7690					8190*	6480	6842	
- 4.5m					8820*	8820*							7170*	7170*	5388	

**LIFT CAPACITIES – Dipper length: 2.63m, Boom: 6.45m, Trackshoes: 600mm triple grouser. JS330 LC MONO**

Load Point	Reach from Swing Centre															
	1.5m		3m		4.5m		6m		7.5m		9m		Max Reach			
																
Height	kg	kg	kg	kg	kg	kg	kg	kg	kg	kg	kg	kg	kg	kg	kg	mm
7.5m													7960*	7230	7008	
6m							8530*	8530*	7810*	6430			7720*	5770	7972	
4.5m					12240*	12240*	9520*	8800	8180*	6250			7420	5030	8567	
3m					14820*	12400	10690*	8290	8730*	6010			6910	4650	8867	
1.5m					14130*	11680	11600*	7870	8710	5780			6760	4520	8905	
0m					16070*	11460	11890	7620	8540	5630			6940	4620	8682	
- 1.5m			11800*	11800*	15140*	11480	11580*	7550	8490	5590			7540	5000	8178	
- 3m			16800*	16800*	13380*	11650	10390*	7640					7950*	5860	7334	
- 4.5m			12540*	12540*	10220*	10220*	7380*	7380*					7370*	7370*	6004	





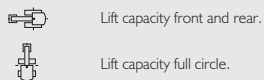









**LIFT CAPACITIES – Dipper length: 3.23m, Boom: 6.45m, Trackshoes: 600mm triple grouser. JS330 LC MONO**

Load Point	Reach from Swing Centre															
	1.5m		3m		4.5m		6m		7.5m		9m		Max Reach			
																
Height	kg	kg	kg	kg	kg	kg	kg	kg	kg	kg	kg	kg	kg	kg	kg	mm
7.5m										6740*	6580		5540*	5540*	7713	
6m										7210*	6530		5350*	5140	8597	
4.5m							8830*	8830*	7680*	6320	6540*	4680	5350*	4540	9150	
3m					13720*	12750	10100*	8390	8320*	6040	6770	4560	5530*	4220	9432	
1.5m					15630*	11850	11190*	7910	8710	5780	6630	4430	5890*	4100	9467	
0m					16160*	11450	11780*	7600	8500	5590	6530	4340	6270	4170	9258	
- 1.5m			11700*	11700*	15650*	11350	11720	7470	8400	5500			6730	4460	8788	
- 3m			18510*	18510*	14270*	11450	10900*	7490	8380*	5530			7510*	5090	8009	
- 4.5m			15240*	15240*	11720*	11720*	8880*	7690					7270*	6500	6815	

















- Notes:**
- Lifting capacities are based on ISO 10567, that is: 75% of minimum tipping load or 87% of hydraulic lift capacity, whichever is the less. Lifting capacities marked\* are based on hydraulic capacity.
  - Lift capacities assume that the machine is on firm, level ground.
  - Lift capacities may be limited by local regulations. Please refer to your dealer.















**LIFT CAPACITIES – Dipper length: 4.03m, Boom: 6.45m, Tracks: 600mm triple grouser. JS330 LC MONO**

Load Point	Reach from Swing Centre															
	1.5m		3m		4.5m		6m		7.5m		9m		Max Reach			
															mm	
Height	kg	kg	kg	kg	kg	kg	kg	kg	kg	kg	kg	kg	kg	kg	kg	mm
9m														4890*	4890*	7396
7.5m														4550*	4550*	8586
6m									6520*	6520*	5990*	4930	4430*	4430*	9387	
4.5m									7080*	6520	6550*	4830	4450*	4080	9895	
3m					12310*	12310*	9350*	8710	7820*	6220	6900	4680	4590*	3820	10156	
1.5m					14730*	12320	10650*	8160	8550*	5930	6730	4510	4870*	3710	10189	
0m			7390*	7390*	15970*	11670	11540*	7760	8610	5680	6580	4380	5330*	3750	9995	
- 1.5m	7330*	7330*	11080*	11080*	16080*	11400	11800	7530	8440	5530	6490	4300	5960	3960	9562	
- 3m	11460*	11460*	15900*	15900*	15250*	11390	11440*	7460	8390	5480			6660	4410	8853	
- 4.5m	16330*	16330*	18410*	18410*	13390*	11560	10150*	7560	7600*	5590			7070*	5330	7792	
- 6m			13160*	13160*	9900*	9900*	7070*	7070*					6650*	6650*	6196	

**LIFT CAPACITIES – Dipper length: 2.21m, Boom: 6.45m, Tracks: 600mm triple grouser. JS330 NLC MONO**

Load Point	Reach from Swing Centre															
	1.5m		3m		4.5m		6m		7.5m		9m		Max Reach			
															mm	
Height	kg	kg	kg	kg	kg	kg	kg	kg	kg	kg	kg	kg	kg	kg	kg	mm
7.5m							8640*	8520						8580*	7440	6491
6m							8960*	8320	8240	5790			8240	5750	7523	
4.5m					12990*	11990	9900*	7900	8470*	5650			7940	4930	8151	
3m							11000*	7420	8840	5420			7340	4520	8467	
1.5m							11760*	7050	8620	5220			7170	4380	8506	
0m					15700*	10290	11790	6860	8480	5100			7390	4490	8273	
- 1.5m					14560*	10350	11340*	6840	8480	5100			8120	4910	7741	
- 3m			14810*	14810*	12550*	10550	9820*	6970					8190*	5890	6842	
- 4.5m					8820*	8820*							7170*	7170*	5388	





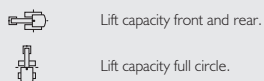









**LIFT CAPACITIES – Dipper length: 2.63m, Boom: 6.45m, Tracks: 600mm triple grouser. JS330 NLC MONO**

Load Point	Reach from Swing Centre															
	1.5m		3m		4.5m		6m		7.5m		9m		Max Reach			
															mm	
Height	kg	kg	kg	kg	kg	kg	kg	kg	kg	kg	kg	kg	kg	kg	kg	mm
7.5m														7960*	6650	7008
6m							8530*	8480	7810*	5900			7720*	5300	7972	
4.5m					12240*	12240*	9520*	8050	8180*	5730			7390	4600	8567	
3m					14820*	11190	10690*	7560	8730*	5500			6880	4250	8867	
1.5m					14130*	10490	11600*	7150	8680	5270			6730	4120	8905	
0m					16070*	10280	11840	6910	8510	5120			6910	4200	8682	
- 1.5m			11800*	11800*	15140*	10300	11580*	6840	8460	5080			7500	4550	8178	
- 3m			16800*	16800*	13380*	10470	10390*	6920					7950*	5340	7334	
- 4.5m			12540*	12540*	10220*	10220*	7380*	7240					7370*	7240	6004	

















- Notes:**
- Lifting capacities are based on ISO 10567, that is: 75% of minimum tipping load or 87% of hydraulic lift capacity, whichever is the less. Lifting capacities marked\* are based on hydraulic capacity.
  - Lift capacities assume that the machine is on firm, level ground.
  - Lift capacities may be limited by local regulations. Please refer to your dealer.















**LIFT CAPACITIES – Dipper length: 3.23m, Boom: 6.45m, Trackshoes: 600mm triple grouser. JS330 NLC MONO**

Load Point	Reach from Swing Centre														
	1.5m		3m		4.5m		6m		7.5m		9m		Max Reach		
															
Height	kg	kg	kg	kg	kg	kg	kg	kg	kg	kg	kg	kg	kg	kg	mm
7.5m									6740*	6060			5540*	5540*	7713
6m									7210*	6000			5350*	4720	8597
4.5m							8830*	8180	7680*	5790	6540*	4280	5350*	4150	9150
3m					13720*	11530	10100*	7650	8320*	5520	6740	4160	5530*	3850	9432
1.5m					15630*	10650	11190*	7190	8680	5270	6600	4040	5890*	3730	9467
0m					16160*	10270	11780*	6880	8460	5080	6500	3940	6420	3790	9258
- 1.5m			11700*	11700*	15650*	10180	11670	6750	8360	4990			6700	4050	8788
- 3m			18510*	18510*	14270*	10270	10900*	6770	8380*	5020			7510*	4630	8009
- 4.5m			15240*	15240*	11720*	10540	8880*	6970					7270*	5910	6815

**LIFT CAPACITIES – Dipper length: 4.03m, Boom: 6.45m, Trackshoes: 600mm triple grouser. JS330 NLC MONO**

Load Point	Reach from Swing Centre														
	1.5m		3m		4.5m		6m		7.5m		9m		Max Reach		
															
Height	kg	kg	kg	kg	kg	kg	kg	kg	kg	kg	kg	kg	kg	kg	mm
9m													4890*	4890*	7396
7.5m													4550*	4550*	8586
6m									6520*	6220	5990*	4520	4430*	4170	9387
4.5m									7080*	5990	6550*	4430	4450*	3730	9895
3m					12310*	12180	9350*	7960	7820*	5700	6880	4280	4590*	3480	10156
1.5m					14730*	11110	10650*	7430	8550*	5410	6700	4120	4870*	3380	10189
0m			7390*	7390*	15970*	10480	11540*	7030	8570	5170	6550	3980	5330*	3410	9995
- 1.5m	7330*	7330*	11080*	11080*	16080*	10220	11750	6810	8400	5020	6460	3900	5940	3590	9562
- 3m	11460*	11460*	15900*	15900*	15250*	10210	11440*	6750	8360	4980			6630	4000	8853
- 4.5m	16330*	16330*	18410*	18410*	13390*	10380	10150*	6840	7600*	5080			7070*	4850	7792
- 6m			13160*	13160*	9900*	9900*	7070*	7070*					6650*	6650*	6196





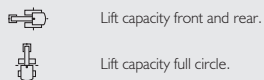









**LIFT CAPACITIES – Dipper length: 2.21m, Boom: 6.10m, Trackshoes: 600mm triple grouser. JS330 LC ME**

Load Point	Reach from Swing Centre														
	1.5m		3m		4.5m		6m		7.5m		9m		Max Reach		
															
Height	kg	kg	kg	kg	kg	kg	kg	kg	kg	kg	kg	kg	kg	kg	mm
7.5m							9260*	9260*					9270*	9270*	6073
6m							9280*	9280*					8800*	7030	7166
4.5m					12840*	12840*	10080*	9020	8780*	6410			8640*	5980	7824
3m							11110*	8560	9160*	6210			8100	5480	8152
1.5m							11870*	8180	9010	6020			7920	5330	8193
0m					16020*	12030	12010*	7970	8880	5910			8190	5480	7950
- 1.5m			15520*	15520*	14750*	12080	11340*	7950					8690*	6050	7396
- 3m			15030*	15030*	12370*	12300	9390*	8120					8330*	7410	6447

















- Notes:**
- Lifting capacities are based on ISO 10567, that is: 75% of minimum tipping load or 87% of hydraulic lift capacity, whichever is the less. Lifting capacities marked\* are based on hydraulic capacity.
  - Lift capacities assume that the machine is on firm, level ground.
  - Lift capacities may be limited by local regulations. Please refer to your dealer.















**LIFT CAPACITIES – Dipper length: 2.63m, Boom: 6.10m, Trackshoes: 600mm triple grouser. JS330 LC ME**

Load Point	Reach from Swing Centre														
	1.5m		3m		4.5m		6m		7.5m		9m		Max Reach		
															
Height	kg	kg	kg	kg	kg	kg	kg	kg	kg	kg	kg	kg	kg	kg	mm
7.5m							8520*	8520*					7690*	7690*	6614
6m							8750*	8750*	8200*	6580			7270*	6390	7629
4.5m					12060*	12060*	9630*	9120	8410*	6460			7220*	5520	8248
3m					14590*	13100	10750*	8640	8890*	6240			7430*	5090	8561
1.5m					16150*	12330	11660*	8230	9010	3020			7360	4950	8599
0m					16250*	12030	12000*	7980	8850	5880			7580	5070	8369
- 1.5m			14930*	14930*	15290*	12010	11580*	7900	8820	5850			8260*	5530	7844
- 3m			17010*	17010*	13250*	12180	10090*	8000					8060*	6600	6958
- 4.5m					9340*	9340*							7070*	7070*	5536

**LIFT CAPACITIES – Dipper length: 2.21m, Boom: 6.10m, Trackshoes: 600mm triple grouser. JS330 NLC ME**

Load Point	Reach from Swing Centre														
	1.5m		3m		4.5m		6m		7.5m		9m		Max Reach		
															
Height	kg	kg	kg	kg	kg	kg	kg	kg	kg	kg	kg	kg	kg	kg	mm
7.5m							9260*	8720					9270*	8540	6073
6m							9280*	8630					8800*	6450	7166
4.5m					12840*	12650	10080*	8260	8780*	5870			8640*	5480	7824
3m							11110*	7800	9160*	5680			8070	5010	8152
1.5m							11870*	7430	8970	5490			7880	4860	8193
0m					16020*	10800	12010*	7230	8850	5380			8160	5000	7950
- 1.5m			15520*	15520*	14750*	10850	11340*	7200					8690*	5510	7396
- 3m			15030*	15030*	12370*	11070	9390*	7370					8330*	6740	6447





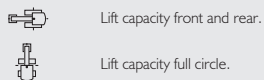









**LIFT CAPACITIES – Dipper length: 2.63m, Boom: 6.10m, Trackshoes: 600mm triple grouser. JS330 NLC ME**

Load Point	Reach from Swing Centre														
	1.5m		3m		4.5m		6m		7.5m		9m		Max Reach		
															
Height	kg	kg	kg	kg	kg	kg	kg	kg	kg	kg	kg	kg	kg	kg	mm
7.5m							8520*	8520*					7690*	7460	6614
6m							8750	8730	8200*	6040			7270*	5860	7629
4.5m					12060*	12060*	9630*	8350	8410*	5920			7220*	5050	8248
3m					14590*	11830	10750*	7880	8890*	5700			7430*	4650	8561
1.5m					16150*	11090	11660*	7480	8970	5490			7320	4510	8599
0m					16250*	10800	12000*	7230	8820	5350			7540	4620	8369
- 1.5m			14930*	14930*	15290*	10790	11580*	7160	8790	5320			8260*	5040	7844
- 3m			17010*	17010*	13250*	10950	10090*	7260					8060*	6000	6958
- 4.5m					9340*	9340*							7070*	7070*	5536

















- Notes:**
- Lifting capacities are based on ISO 10567, that is: 75% of minimum tipping load or 87% of hydraulic lift capacity, whichever is the less. Lifting capacities marked\* are based on hydraulic capacity.
  - Lift capacities assume that the machine is on firm, level ground.
  - Lift capacities may be limited by local regulations. Please refer to your dealer.















**LIFT CAPACITIES – Dipper length: 2.21m, Boom: 6.45m, Trackshoes: 600mm triple grouser. JS330 LC T.A.B.**

Load Point	Reach from Swing Centre															
	1.5m		3m		4.5m		6m		7.5m		9m		Max Reach			
																
Height	kg	kg	kg	kg	kg	kg	kg	kg	kg	kg	kg	kg	kg	kg	kg	mm
9m					13120*	13120*								12540*	11760	4959
7.5m					12840*	12840*	10740*	8680						10230*	7310	6613
6m					13740*	13320	10940*	8460	9310*	5870				9170	5690	7628
4.5m					15300*	12170	11480*	8010	9290	5720				7960	4900	8248
3m							11910*	7510	9030	5490				7380	4510	8560
1.5m							11770*	7130	8810	5290				7230	4390	8599
0m							10810*	6960	8430*	5180				6890*	4510	8368
- 1.5m					10280*	10280*	8960*	6960	6700*	5210				5900*	4950	7844

**LIFT CAPACITIES – Dipper length: 2.21m, Boom: 6.45m, Trackshoes: 600mm triple grouser. JS330 NLC T.A.B.**

Load Point	Reach from Swing Centre															
	1.5m		3m		4.5m		6m		7.5m		9m		Max Reach			
																
Height	kg	kg	kg	kg	kg	kg	kg	kg	kg	kg	kg	kg	kg	kg	kg	mm
9m					13120*	13120*								12540*	12540*	4959
7.5m					12840*	12840*	10740*	9470						10230*	7980	6613
6m					13740*	13740*	10940*	9250	9310*	6420				9200*	6220	7628
4.5m					15300*	13460	11480*	8780	9330	6270				7990	5370	8248
3m							11910*	8270	9070	6030				7420	4960	8560
1.5m							11770*	7890	8840	5830				7260	4830	8599
0m							10810*	7710	8430*	5720				6890*	4970	8368
- 1.5m					10280*	10280*	8960*	7710	6700*	5740				5900*	5450	7844

**LIFT CAPACITIES – Dipper length: 2.21m, Boom: 6.45m, Trackshoes: 600mm triple grouser. JS370 LC MONO**



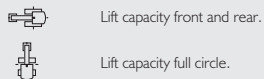









Load Point	Reach from Swing Centre															
	1.5m		3m		4.5m		6m		7.5m		9m		Max Reach			
																
Height	kg	kg	kg	kg	kg	kg	kg	kg	kg	kg	kg	kg	kg	kg	kg	mm
7.5m							9990*	9990*						9920*	9240	6498
6m							10380*	10340	9540*	7210				9530*	7170	7523
4.5m					15020*	15020*	11460*	9840	9810*	7040				9380	6170	8146
3m							12710*	9280	10350*	6780				8690	5680	8457
1.5m							13580*	8850	10170	6550				8490	5520	8492
0m					18080*	13050	13740*	8630	10020	6410				8760	5660	8253
- 1.5m					16750*	13130	13080*	8610	10020	6410				9650	6200	7715
- 3m			17020*	17020*	14420*	13370	11310*	8770						9510	7450	6806
- 4.5m					10100*	10100*								8330*	8330*	5334

















- Notes:**
- Lifting capacities are based on ISO 10567, that is: 75% of minimum tipping load or 87% of hydraulic lift capacity, whichever is the less. Lifting capacities marked\* are based on hydraulic capacity.
  - Lift capacities assume that the machine is on firm, level ground.
  - Lift capacities may be limited by local regulations. Please refer to your dealer.

















**LIFT CAPACITIES – Dipper length: 2.63m, Boom: 6.45m, Tracks: 600mm triple grouser. JS370 LC MONO**

Load Point	Reach from Swing Centre															
	1.5m		3m		4.5m		6m		7.5m		9m		Max Reach			
																
Height	kg	kg	kg	kg	kg	kg	kg	kg	kg	kg	kg	kg	kg	kg	mm	
7.5m														9170*	8240	7006
6m							9810*	9810*	9000*	7300				8910*	6570	7965
4.5m					14080*	14080*	10960*	9950	9420*	7090				8700	5730	8555
3m					17070*	14020	12300*	9370	10050*	6800				8100	5290	8852
1.5m							13340*	8890	10170	6540				7920	5150	8884
0m					18460*	13000	13710*	8620	9980	6370				8140	5260	8657
- 1.5m			14240*	14240*	17380*	13020	13300*	8540	9930	6320				8860	5690	8146
- 3m			19260*	19260*	15330*	13210	11900*	8650						9200*	6690	7292
- 4.5m					11640*	11640*								8530*	8530*	5945

**LIFT CAPACITIES – Dipper length: 3.23m, Boom: 6.45m, Tracks: 600mm triple grouser. JS370 LC MONO**

Load Point	Reach from Swing Centre															
	1.5m		3m		4.5m		6m		7.5m		9m		Max Reach			
																
Height	kg	kg	kg	kg	kg	kg	kg	kg	kg	kg	kg	kg	kg	kg	mm	
7.5m									7870*	7480				6630*	6630	7704
6m									8290*	7400				6410*	5850	8584
4.5m							10170*	10120	8840*	7150	7610*	5300		6430*	5160	9134
3m					15790*	14430	11620*	9500	9570*	6840	7910	5160		6660*	4800	9412
1.5m					17960*	13410	12860*	8950	10180	6540	7740	5010		7120*	4660	9443
0m					18540*	12960	13520*	8600	9940	6320	7620	4900		7360	4740	9229
- 1.5m			14080*	14080*	17940*	12860	13440*	8450	9820	6220				7900	5070	8753
- 3m			21920*	21920*	16340*	12980	12480*	8480	9590*	6260				8680*	5810	7965
- 4.5m			17390*	17390*	13390*	13310	10140*	8710						8430*	7450	6757





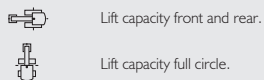









**LIFT CAPACITIES – Dipper length: 4.03m, Boom: 6.45m, Tracks: 600mm triple grouser. JS370 LC MONO**

Load Point	Reach from Swing Centre															
	1.5m		3m		4.5m		6m		7.5m		9m		Max Reach			
																
Height	kg	kg	kg	kg	kg	kg	kg	kg	kg	kg	kg	kg	kg	kg	mm	
9m														5570*	5570*	7419
7.5m														5160*	5160*	8601
6m									7350*	7350*	6770*	5470		5010*	5010*	9396
4.5m									7980*	7240	7380*	5340		5020*	4490	9900
3m					13900*	13900*	10540*	9660	8810*	6880	7790*	5150		5170*	4190	10157
1.5m					16630*	13630	12000*	9000	9630*	6520	7690	4950		5490*	4070	10185
0m			8770*	8770*	18020*	12880	12990*	8530	9860	6230	7510	4780		5990*	4100	9988
- 1.5m	8670*	8670*	13160*	13160*	18120*	12580	13310*	8260	9660	6050	7410	4690		6830	4330	9549
- 3m	13590*	13590*	18910*	18910*	17150*	12570	12850*	8200	9610	6010				7640	4840	8835
- 4.5m	19430*	19430*	20660*	20660*	15010*	12790	11370*	8320	8490*	6150				7930*	5890	7766
- 6m			14590*	14590*	10990*	10990*	7800*	7800*						7420*	7420*	6156

















- Notes:**
- Lifting capacities are based on ISO 10567, that is: 75% of minimum tipping load or 87% of hydraulic lift capacity, whichever is the less. Lifting capacities marked\* are based on hydraulic capacity.
  - Lift capacities assume that the machine is on firm, level ground.
  - Lift capacities may be limited by local regulations. Please refer to your dealer.















**LIFT CAPACITIES – Dipper length: 2.21m, Boom: 6.45m, Trackshoes: 600mm triple grouser. JS370 NLC MONO**

Load Point	Reach from Swing Centre														
	1.5m		3m		4.5m		6m		7.5m		9m		Max Reach		
															
Height	kg	kg	kg	kg	kg	kg	kg	kg	kg	kg	kg	kg	kg	kg	mm
7.5m							9990*	9740					9920*	8490	6498
6m							10380*	9500	9540*	6620			9530*	6590	7523
4.5m					15020*	13630	11460*	9000	9810*	6460			9360	5660	8146
3m							12710*	8450	10350*	6200			8660	5190	8457
1.5m							13580*	8030	10140	5970			8470	5030	8492
0m					18080*	11720	13740*	7820	9990	5830			8740	5160	8253
- 1.5m					16750*	11790	13080*	7800	10000	5840			9620	5640	7715
- 3m			17020*	17020*	14420*	12020	11310*	7960					9510*	6790	6806
- 4.5m					10100*	10100*							8330*	8330*	5334

**LIFT CAPACITIES – Dipper length: 2.63m, Boom: 6.45m, Trackshoes: 600mm triple grouser. JS370 NLC MONO**

Load Point	Reach from Swing Centre														
	1.5m		3m		4.5m		6m		7.5m		9m		Max Reach		
															
Height	kg	kg	kg	kg	kg	kg	kg	kg	kg	kg	kg	kg	kg	kg	mm
7.5m													9170*	7580	7006
6m							9810*	9610	9000*	6700			8910*	6040	7965
4.5m					14080*	13690	10960*	9110	9420*	6500			8680	5240	8555
3m					17070*	12650	12300*	8540	10050*	6220			8080	4840	8852
1.5m							13340*	8080	10150	5960			7900	4690	8884
0m					18460*	11670	13710*	7810	9960	5790			8120	4790	8657
- 1.5m			14240*	14240*	17380*	11690	13300*	7740	9900	5750			8840	5180	8146
- 3m			19260*	19260*	15330*	11870	11900*	7840					9200*	6090	7292
- 4.5m					11640*	11640*							8530*	8310	5945





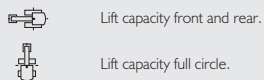









**LIFT CAPACITIES – Dipper length: 3.23m, Boom: 6.45m, Trackshoes: 600mm triple grouser. JS370 NLC MONO**

Load Point	Reach from Swing Centre														
	1.5m		3m		4.5m		6m		7.5m		9m		Max Reach		
															
Height	kg	kg	kg	kg	kg	kg	kg	kg	kg	kg	kg	kg	kg	kg	mm
7.5m									7870*	6880			6630*	6540	7704
6m									8290*	6810			6410*	5370	8584
4.5m							10170*	9270	8840*	6560	7610*	4850	6430*	4720	9134
3m					15790*	13050	11620*	8660	9570*	6250	7880	4710	6660*	4380	9412
1.5m					17960*	12060	12860*	8130	10160	5960	7720	4570	7120*	4240	9443
0m					18540*	11620	13520*	7790	9910	5740	7600	4460	7340	4310	9229
- 1.5m			14080*	14080*	17940*	11530	13440*	7640	9800	5640			7880	4610	8753
- 3m			21920*	21920*	16340*	11640	12480*	7670	9590*	5680			8680*	5280	7965
- 4.5m			17390*	17390*	13390*	11960	10140*	7900					8430*	6780	6757

















- Notes:**
- Lifting capacities are based on ISO 10567, that is: 75% of minimum tipping load or 87% of hydraulic lift capacity, whichever is the less. Lifting capacities marked\* are based on hydraulic capacity.
  - Lift capacities assume that the machine is on firm, level ground.
  - Lift capacities may be limited by local regulations. Please refer to your dealer.















**LIFT CAPACITIES – Dipper length: 4.03m, Boom: 6.45m, Trackshoes: 600mm triple grouser. JS370 NLC MONO**

Load Point	Reach from Swing Centre															
	1.5m		3m		4.5m		6m		7.5m		9m		Max Reach			
																
Height	kg	kg	kg	kg	kg	kg	kg	kg	kg	kg	kg	kg	kg	kg	mm	
9m														5570*	5570*	7419
7.5m														5160*	5160*	8601
6m									7350*	6930	6770*	5010	5010*	4610	9396	
4.5m									7980*	6650	7380*	4890	5020*	4100	9900	
3m					13900*	13530	10540*	8820	8810*	6290	7790*	4700	5170*	3810	10157	
1.5m					16630*	12270	12000*	8180	9630*	5930	7670	4500	5490*	3690	10185	
0m			8770*	8770*	18020*	11540	12990*	7710	9830	5650	7490	4340	5990*	3720	9988	
- 1.5m	8670*	8670*	13160*	13160*	18120*	11250	13310*	7450	9630	5470	7390	4250	6810	3920	9549	
- 3m	13590*	13590*	18910*	18910*	17150*	11240	12850*	7390	9590	5430			7620	4390	8835	
- 4.5m	19430*	19430*	20660*	20660*	15010*	11460	11370*	7510	8490*	5570			7930*	5340	7766	
- 6m			14590*	14590*	10990*	10990*	7800*	7800*					7420*	7420*	6156	

**LIFT CAPACITIES – Dipper length: 2.21m, Boom: 6.1m, Trackshoes: 600mm triple grouser. JS370 LC ME**

Load Point	Reach from Swing Centre															
	1.5m		3m		4.5m		6m		7.5m		9m		Max Reach			
																
Height	kg	kg	kg	kg	kg	kg	kg	kg	kg	kg	kg	kg	kg	kg	mm	
7.5m								10720*	10540					10730*	10310	6075
6m								10770*	10430					10200*	7800	7163
4.5m					14930*	14930*	11720*	9990	10200*	7110				10030*	6650	7815
3m							12910*	9470	10540	6890				9290	6100	8139
1.5m							13780*	9050	10310	6670				9090	5920	8175
0m					18550*	13300*	13930	8830	10170	6550				9410	6100	7926
- 1.5m			18720*	18720*	17070*	13360	13140*	8800						10150*	6740	7364
- 3m			17380*	17380*	14300*	13610	10850*	9000						9740*	8280	6405





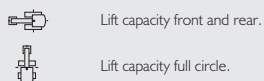









**LIFT CAPACITIES – Dipper length: 2.63m, Boom: 6.45m, Trackshoes: 600mm triple grouser. JS370 LC ME**

Load Point	Reach from Swing Centre															
	1.5m		3m		4.5m		6m		7.5m		9m		Max Reach			
																
Height	kg	kg	kg	kg	kg	kg	kg	kg	kg	kg	kg	kg	kg	kg	mm	
7.5m								9880*	9880*					9280*	9070	6607
6m								10160*	10160*	9510*	7300			8810*	7100	7618
4.5m					14010*	14010*	11190*	10100	9770*	7160				8790*	6140	8233
3m					16930*	14460	12490*	9560	10330*	6910				8630	5660	8541
1.5m					18710*	13610	13530*	9100	10300	6670				8440	5510	8575
0m					18800*	13290	13910*	8820	10130	6510				8700	5650	8339
- 1.5m			18000*	18000*	17680*	13270	13400*	8730	10100	6480				9560	6160	7807
- 3m			19630*	19630*	15310*	13460	11660*	8850						9450*	7360	6911
- 4.5m					10750*	10750*								8320*	8320*	5468

















- Notes:**
- Lifting capacities are based on ISO 10567, that is: 75% of minimum tipping load or 87% of hydraulic lift capacity, whichever is the less. Lifting capacities marked\* are based on hydraulic capacity.
  - Lift capacities assume that the machine is on firm, level ground.
  - Lift capacities may be limited by local regulations. Please refer to your dealer.















**LIFT CAPACITIES – Dipper length: 2.21m, Boom: 6.45m, Trackshoes: 600mm triple grouser. JS370 NLC ME**

Load Point	Reach from Swing Centre														
	1.5m		3m		4.5m		6m		7.5m		9m		Max Reach		
															
Height	kg	kg	kg	kg	kg	kg	kg	kg	kg	kg	kg	kg	kg	kg	mm
7.5m							10720*	9690					10730*	9480	6075
6m							10770*	9580					10200*	7170	7163
4.5m					14930*	14010	11720*	9160	10200*	6520			10030*	6100	7815
3m							12910*	8650	10520	6300			9270	5580	8139
1.5m							13780*	8240	10280	6100			9060	5410	8175
0m					18550*	11960	13930*	8020	10140	5980			9390	5570	7926
- 1.5m			18720*	18720*	17070*	12020	13140*	7990					10150*	6150	7364
- 3m			17380*	17380*	14300*	12260	10850*	8180					9740*	7550	6405

**LIFT CAPACITIES – Dipper length: 2.63m, Boom: 6.45m, Trackshoes: 600mm triple grouser. JS370 NLC ME**

Load Point	Reach from Swing Centre														
	1.5m		3m		4.5m		6m		7.5m		9m		Max Reach		
															
Height	kg	kg	kg	kg	kg	kg	kg	kg	kg	kg	kg	kg	kg	kg	mm
7.5m							9880*	9860					9280*	8340	6607
6m							10160*	9690	9510*	6710			8810*	6530	7618
4.5m					14010*	14010*	11190*	9260	9770*	6570			8790*	5630	8233
3m					16930*	13080	12490*	8730	10330*	6320			8610	5180	8541
1.5m					18710*	12260	13530*	8280	10280	6090			8420	5030	8575
0m					18800*	11950	13910*	8000	10100	5930			8680	5150	8339
- 1.5m			18000*	18000*	17680*	11930	13400*	7920	10070	5900			9530	5620	7807
- 3m			19630*	19630*	15310*	12210	11660*	8040					9450*	6710	6911
- 4.5m					10750*	10750*							8320*	8320*	5468





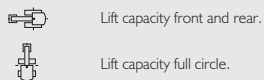









**LIFT CAPACITIES – Dipper length: 2.21m, Boom: 6.45m, Trackshoes: 600mm triple grouser. JS370 LC T.A.B.**

Load Point	Reach from Swing Centre														
	1.5m		3m		4.5m		6m		7.5m		9m		Max Reach		
															
Height	kg	kg	kg	kg	kg	kg	kg	kg	kg	kg	kg	kg	kg	kg	mm
9m					15120*	15120*							14250*	14050	4999
7.5m					14840*	14840*	12440*	10490					11830*	8790	6637
6m					15920*	15920*	12690*	10240	10810*	7120			10500	6880	7644
4.5m							13330*	9720	10670	6950			9120	5950	8257
3m							13840*	9150	10380	6690			8480	5500	8564
1.5m							13670*	8740	10130	6460			8320	5360	8598
0m							12560*	8540	9810*	6340			8030*	5520	8363
- 1.5m					11960*	11960*	10420*	8550	7790*	6380			6890*	6060	7833



- Notes:**
- Lifting capacities are based on ISO 10567, that is: 75% of minimum tipping load or 87% of hydraulic lift capacity, whichever is the less. Lifting capacities marked\* are based on hydraulic capacity.
  - Lift capacities assume that the machine is on firm, level ground.
  - Lift capacities may be limited by local regulations. Please refer to your dealer.

**LIFT CAPACITIES – Dipper length: 2.21m, Boom: 6.45m, Trackshoes: 600mm triple grouser. JS370 NLC T.A.B.**

Load Point	Reach from Swing Centre														
	1.5m		3m		4.5m		6m		7.5m		9m		Max Reach		
															
Height	kg	kg	kg	kg	kg	kg	kg	kg	kg	kg	kg	kg	kg	kg	mm
9m					15120*	15120*							14250*	12860	4999
7.5m					14840*	14840*	12440*	9630					11830*	8060	6637
6m					15920*	14740	12690*	9380	10810*	6520			10470	6300	7644
4.5m							13330*	8880	10640	6360			9100	5440	8257
3m							13840*	8320	10350	6100			8460	5010	8564
1.5m							13670*	7910	10100	5880			8300	4880	8598
0m							12560*	7730	9810*	5760			8030*	5020	8363
- 1.5m					11960*	11730	10420*	7740	7790*	5790			6890*	5520	7833



Lift capacity front and rear.



Lift capacity full circle.

**Notes:**

1. Lifting capacities are based on ISO 10567, that is: 75% of minimum tipping load or 87% of hydraulic lift capacity, whichever is the less. Lifting capacities marked\* are based on hydraulic capacity.
2. Lift capacities assume that the machine is on firm, level ground.
3. Lift capacities may be limited by local regulations. Please refer to your dealer.







**ONE COMPANY, OVER 300 MACHINES.**

Your nearest JCB dealer

### Tracked Excavator JS330/370 LC/NLC

Net engine power: 210kW (281 hp) Bucket capacity: 0.86 - 1.93 m<sup>3</sup> Operating weight: 32972 - 38626 kg

JCB Sales Limited, Rokester, Staffordshire, United Kingdom ST14 5JP.

Tel: +44 (0)1889 590312 Email: [salesinfo@jcb.com](mailto:salesinfo@jcb.com)

Download the very latest information on this product range at: [www.jcb.com](http://www.jcb.com)

©2017 JCB Sales. All rights reserved. No part of this publication may be reproduced, stored in a retrieval system, or transmitted in any form or by any other means, electronic, mechanical, photocopying or otherwise, without prior permission from JCB Sales. All references in this publication to operating weights, sizes, capacities and other performance measurements are provided for guidance only and may vary dependant upon the exact specification of machine. They should not therefore be relied upon in relation to suitability for a particular application. Guidance and advice should always be sought from your JCB Dealer. JCB reserves the right to change specifications without notice. Illustrations and specifications shown may include optional equipment and accessories. All images are correct at time of print. The JCB logo is a registered trademark of J.C. Bamford Excavators Ltd.



9999/5994 en-GB 04/17 Issue 1 (T4F)

