

EDGETEQ

S-500 /

S-500 profiLine

Most widely sold and popular worldwide.

Our 500 series for efficient edge banding.





Perfect edges produced with flexible machines for demanding customers

Individual customer requirements, sophisticated products, and a large range of materials — these are all requirements that play a key role in today's wood processing sector. It is therefore important that production is flexible and efficient, especially in woodworking shops and for medium-sized businesses.

This is what the innovative generation of HOMAG EDGETEQ S-500 edge banding machines is specifically designed for: it offers more equipment and thus even greater flexibility.

YOUR SOLUTION

[MORE AT HOMAG.COM](https://www.homag.com)



CONTENTS

- 04 Highlights
- 06 Material types | Edge parameters | Returns
- 08 EDGETEQ S-500 | Technical data
- 12 Unit technology
- 38 Two-profile technology | Three-profile technology
- 40 Apps and digital assistants
- 42 Software
- 43 powerTouch2
- 44 LOOPTEQ return
- 52 Production lines
- 54 Life Cycle Services

The benefits of the EDGETEQ S-500

- **More flexibility thanks to the extended range of units available**

The MS40 multi-level trimming unit, the MF60 Servotrim multifunction profile trimming unit and the MN11 profile scraper for two profiles can now be used on the EDGETEQ S-500 and provide access to an even wider array of possibilities for individual requirements.

- **Simple processing of PUR**

PUR, EVA and airTec can be processed with one machine on request.

- **Increased availability and shorter machine setup time**

With the AG12 and AG12 Basic gluing units, the application unit for hot-melt glue can be emptied easily in the machine.

- **Less cleaning and increased safety**

Pneumatic metering slides on the application unit for hot-melt glue close automatically, prevent dirt and reduce the amount of cleaning required, e.g. in the event of a power failure.

- **Increased cost efficiency**

The unit combinations can be optimally adapted to your requirements — such as with two-profile technology or three-profile technology.

- **Expandable**

Thanks to the drilling grid, the machines are easier to expand and offer even more protection for your investment.

- **EDGETEQ S-500 profiLine**

The profiLine machines offer an even greater range of configuration options and enormous flexibility.

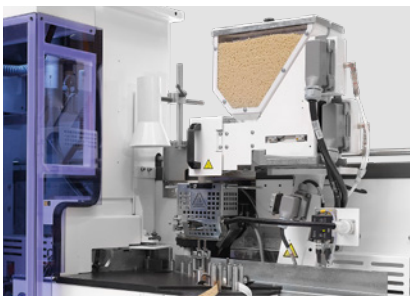

Gluing units for safe hot-melt glue application

HOMAG gluing units are ideal for quick, solid gluing. The heated gluing roller ensures an optimal adhesive temperature. The standard is an EVA melting unit.

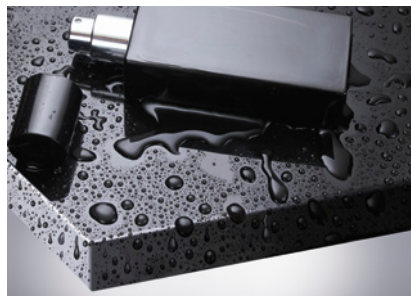

Edge gluing with PUR

At HOMAG, PUR glues are processed on the same machines and with the same application unit as EVA hot-melt glues.



Zero joint technology with HOMAG airTec

The units are now equipped with a rotation fan heater, which improves the efficiency of the process, reduces noise, and ensures a more cost-effective use of resources.

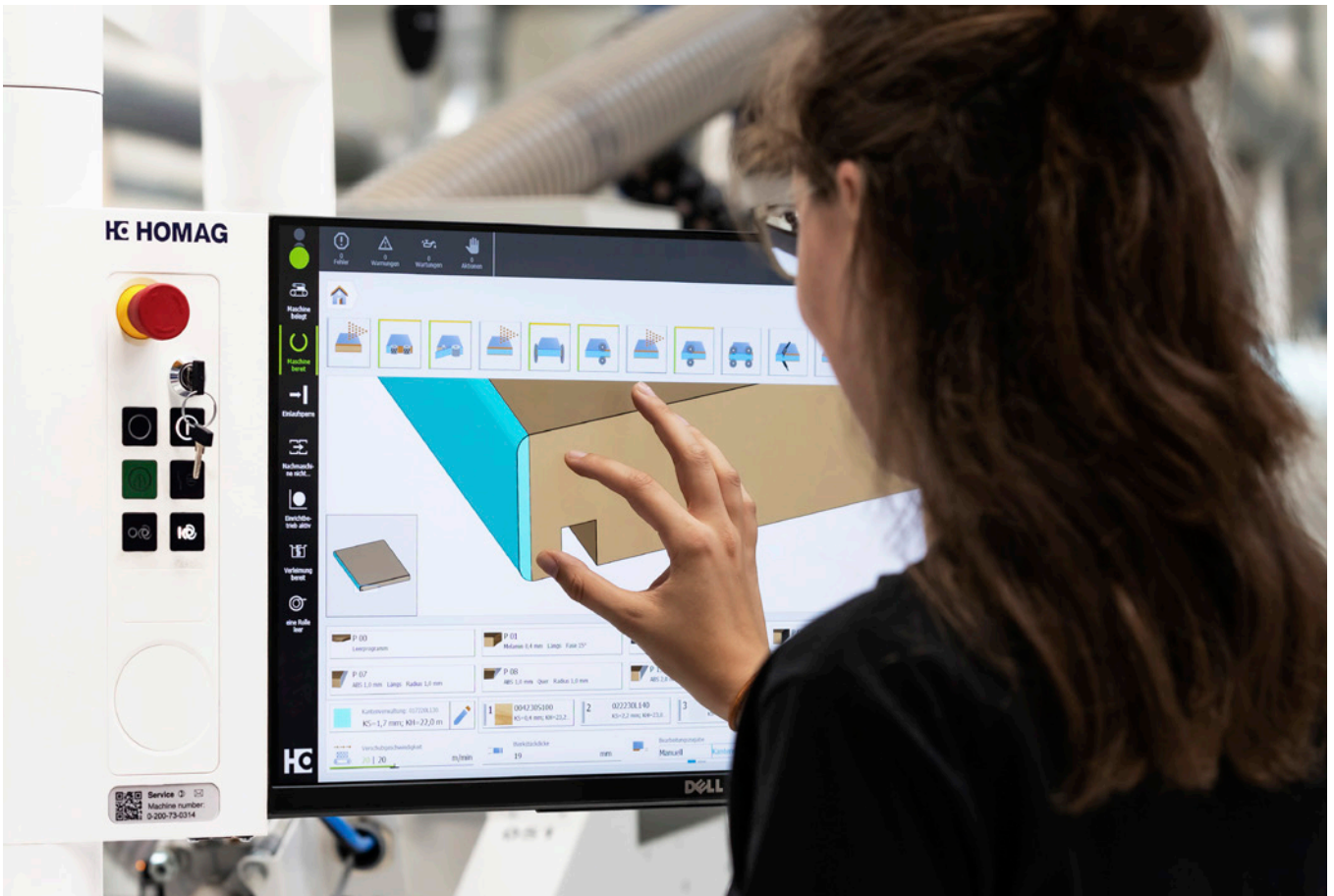

Intuitive operation with the powerTouch control system

Control machine functions directly using the multi-touch, widescreen monitor. The ergonomic design, as well as numerous help and assistant functions, simplify operation significantly.



Belt-type top roll pressure

The top roll pressure element made of steel with double V-belt provides the basis for the highest quality because your workpieces are optimally clamped for processing.



Multi-profile technology

For easy adjustment of the units at the touch of a button. Saves time and increases quality.



Controlled chip collection

The chips are suctioned off in the interior and fed to the extraction hood in a targeted manner. Reduced wear and tear and lower service costs increase profitability and service life. The reduced suction speed lowers energy consumption and costs.



Material types | Edge parameters

A high level of flexibility is achieved through the processing of all types of edge materials: 0.3-mm melamine, 3-mm ABS, PP, PVC and wood as rolls of material. Solid strips and veneer strips are fed in individually up to 12 mm or out of the book up to 20 mm. In addition, veneer strips up to 1 mm can also be fed in from the book.

For perfect high-gloss parts, important components such as the motorized top roll pressure element and the automatic adjustment of the glue joint scrapers are used. Special tracing elements are ideal for processing sharp-angled or blunt-angled parts, or parts with hinge holes and transversal grooves.

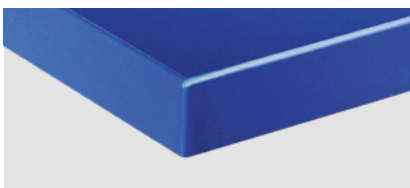

		a	b	c	d	e
	SOLID (mm)			0.4-12.0 (option: 0.4-20.0)		
	ROLLS (mm)	For $b \leq 22$: min. 60 For $b \leq 40$: min. 105	8-60 (option: 8-100) 12-60 (option: 12-100)	0.3-3.0	65 (option: 105)	Max. 25
	STRIPS (mm)			0.4-1.0		



LOOPTEQ returns for increased productivity

The LOOPTEQ series workpiece returns are an optimal addition to machines from the EDGETEQ series. Single-person operation enables you to optimize your workpiece return flow, resulting in a streamlined and efficient production process.

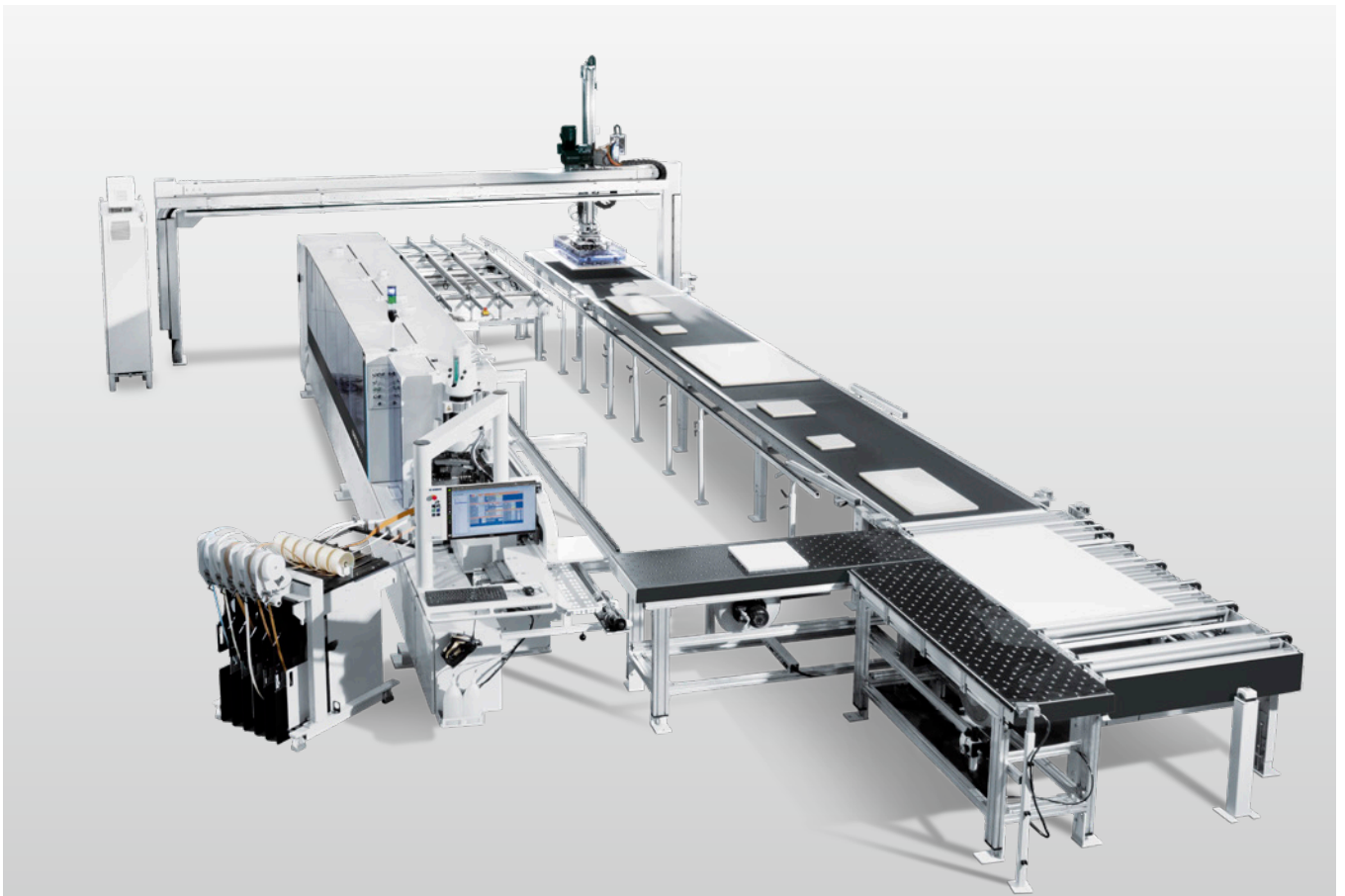

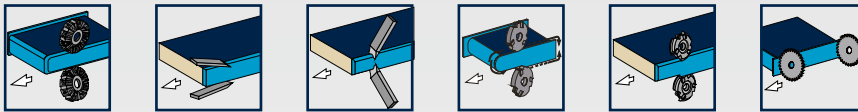
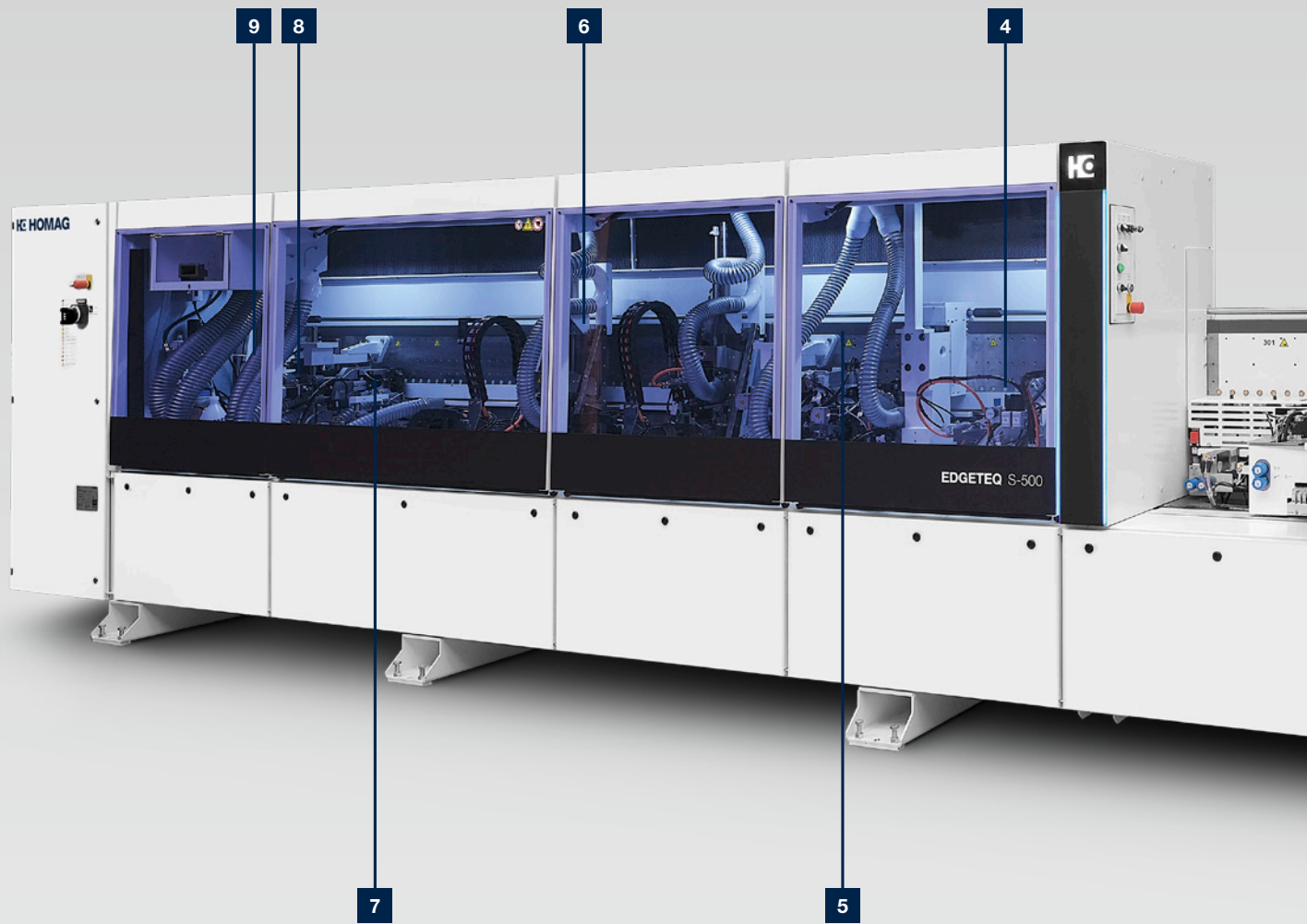

EDGETEQ S-500

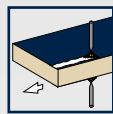
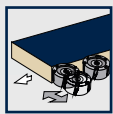
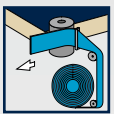
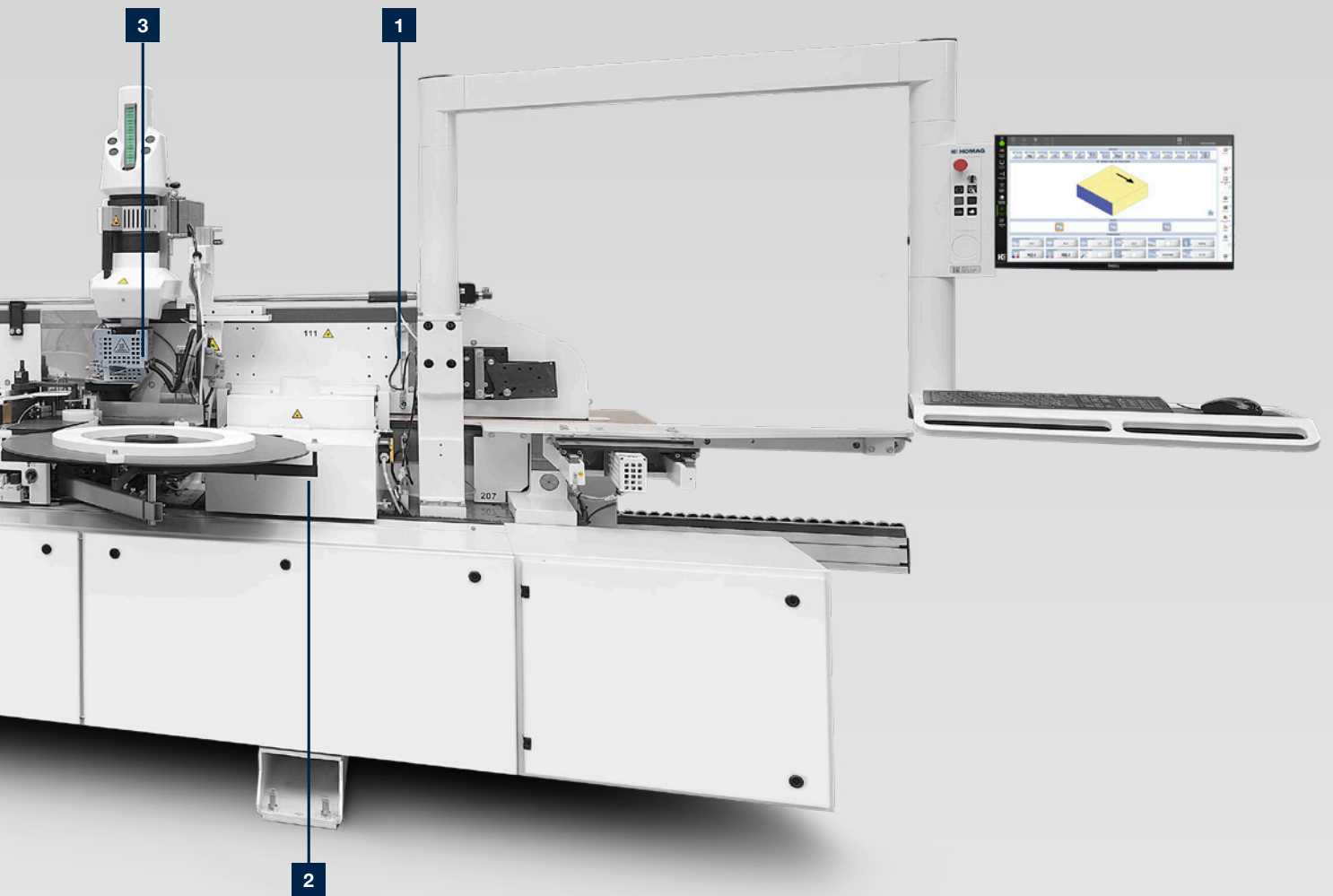

1 Separating agent sprayer

4 Snipping unit

7 Profile scraper

2 Joint trimming unit

5 MS40 multi-level trimming unit

8 Glue joint scraper

3 AG12 Basic gluing unit

6 MF60 Servotrim multifunction profile trimming unit

9 Buffing unit

Machine configurations|

Joining, gluing, post-processing

- **JOINING.** Various adjustment options and joining tools are available for precise join processing.
- **GLUING.** The best possible glue joint quality in terms of price/performance ratio is achieved by the targeted use of the three processes EVA gluing, PUR gluing or airTec.
- **POST-PROCESSING.** Whether only one profile is to be used or changing between two or three profiles is required — there is a suitable solution for all cases, most of which are patented by HOMAG.

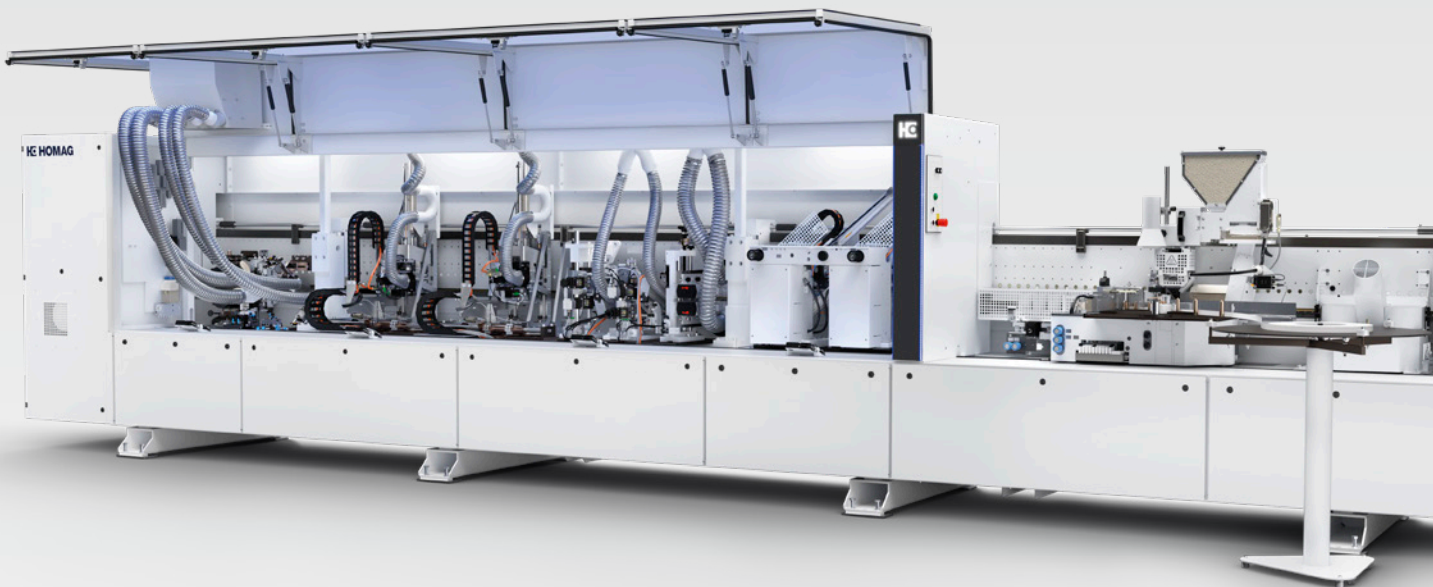



MACHINE DIMENSIONS

Overall length (mm)	Dependent on equipment
Adjustable feed (m/min)	16–20, 25, 28, 30

WORKING DIMENSIONS

Workpiece width (mm)*	
For workpiece thickness 8–22 mm	60
Workpiece thickness (mm)	12–60 (options: 8–60/8–100/12–100)
Edge thickness rollers (mm)	0.3–3
Edge thickness strips/moldings (mm)	0.4–12 (20)

* Dependent on the workpiece thickness



Our unit modules: The right solution, whatever the requirement

For wide-ranging and diverse processing tasks, we use units from our tried-and-tested unit modules. We are constantly expanding our functions so we can offer you the right solution

for new trends. You benefit from a high level of precision and state-of-the-art technology, and the ability to produce your products flexibly and efficiently.

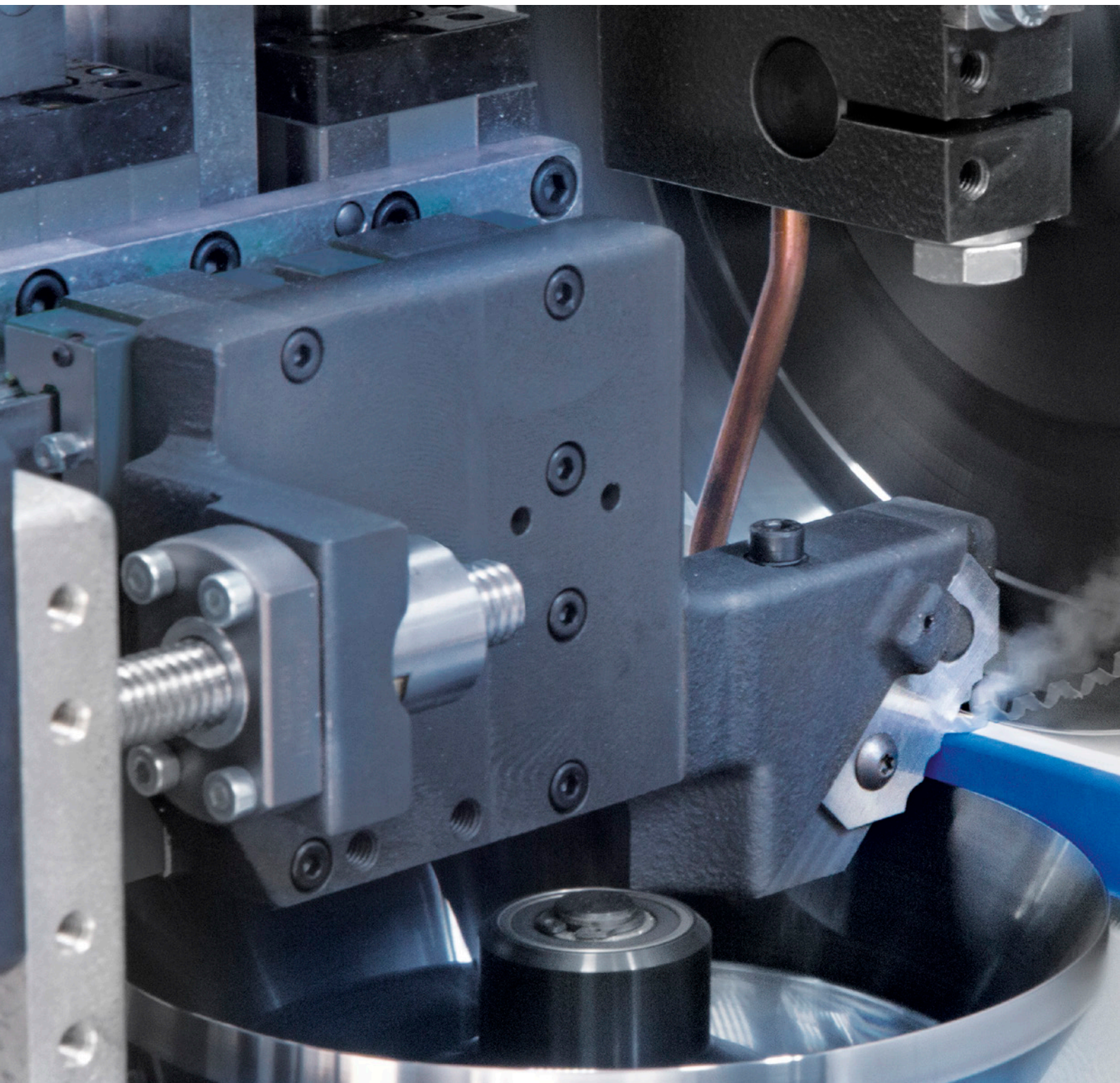



WHAT HOMAG OFFERS YOU

- Perfect trimming quality thanks to vibration-free rotation plus long tool service life due to the HSK interfaces for the post-processing units
- Minimum setup time thanks to three-profile technology for the four-motor FF32 profile trimming unit and automatic adjustment of the glue joint scraper
- Optimum processing of, for example, high-gloss surfaces or lightweight panels thanks to the servo-controlled motion sequence on the MF60 Servotrim multi-function profile trimming unit

Guiding the workpieces

Workpieces need to be fed into machines precisely in order to achieve perfect edge quality. Take advantage of the benefits our solutions have to offer, such as infeed fences, infeed blocks, sliding carriages or workpiece supports.



Wireless manual control

Maximum possible freedom of movement when moving inserting. No tripping hazards due to the cable being carried.

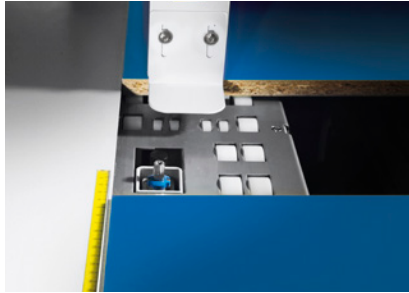

Infeed block

For a minimum workpiece distance and safe operation. Pneumatically controlled.



Air cushion table

For safe feeding of the machine.



Infeed device with two rollers

For safe insertion of workpieces.



Infeed device with six rollers

Inclined, powered Vulkollan rollers for safe insertion of workpieces with a length of at least 250 mm.

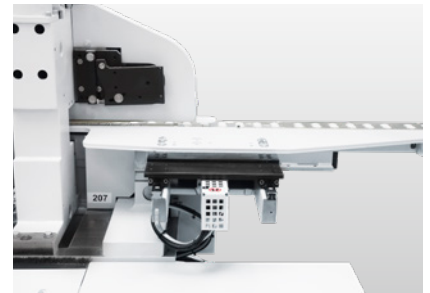

Automatic infeed fence adjustment

Program-controlled, precise and repeatedly accurate adjustment of the infeed fence via the infinitely variable axis.



Sliding carriage

Robust linear guide for feeding the workpieces in at a right angle.



Basic workpiece support

The workpiece support can be moved up to 1000 mm on the profile rails.

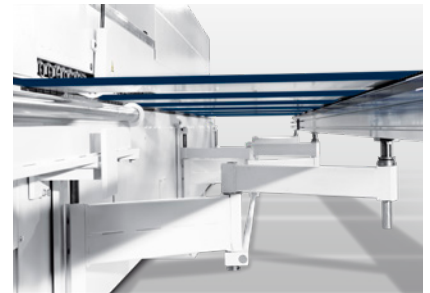

Workpiece support in scissor design

Due to the scissor design, the workpiece support can be comfortably extended up to 1000 mm.

Workpiece feed systems for EDGETEQ S-500 profiLine

HOMAG workpiece feed systems feed your workpieces to the edge processing machine automatically and precisely. They

thus create the basis for high processing quality and efficient processing.



WZ10 workpiece feed system

If your workpieces are already cut parallel and to the correct angle for the unprocessed fixed dimension, we recommend the WZ10 workpiece feed. This is specially designed for transporting pre-formatted workpieces for flexible production.



EZ14 workpiece feed system

With this workpiece feed, parallel cutting with angular accuracy is not necessary. The workpieces are fed in manually at exactly the correct angle in the longitudinal and transverse direction.

Sprayers |

Your requirement, our solution

Sprayers improve the edge quality throughout processing. Separating agents prevent hot-melt glue residues forming deposits and anti-static agents prevent plastic chips forming deposits.

The adhesive residues can be easily removed using cleaning spray. Lubricants prevent shiny marks on the workpieces and protect sensitive surfaces before trimming.

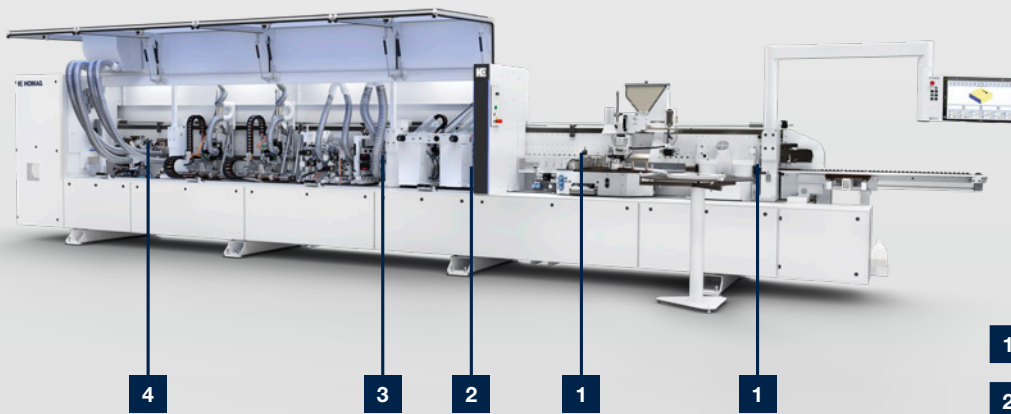

- 1 Separating agent
- 2 Anti-static agent
- 3 Lubricant
- 4 Cleaning agents

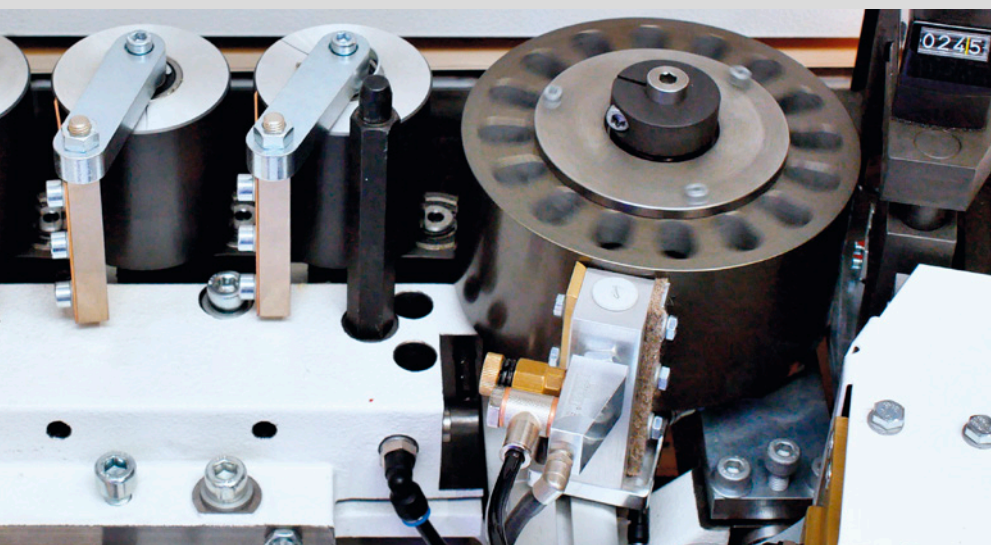

Wetting device

Applying separating agent to the press roller prevents hot-melt glue residues sticking to the roller.

Joint trimming unit | Precision is the basis

Our joint trimming unit forms the basis for precise, absolutely straight and tear-free workpiece edges and glue joints with consistently high product quality.

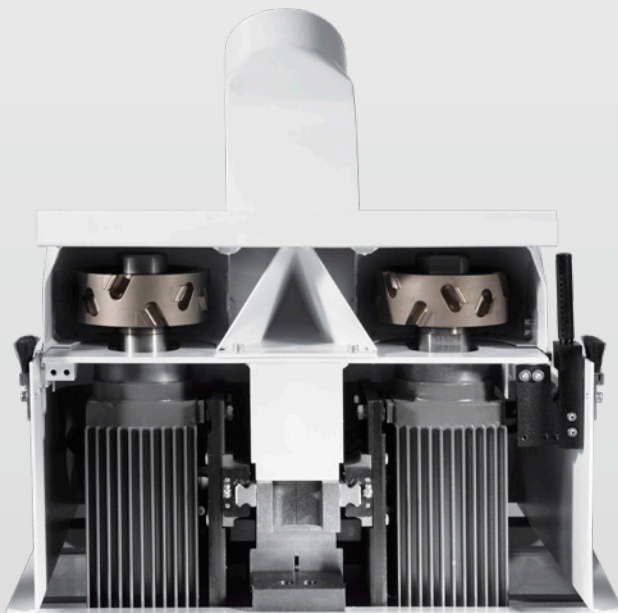

Joint trimming unit

This unit enables highly precise processing, is extremely robust and suitable for an above-average length of service life. The diameter of the low-noise, chip-emission-optimized tool (I-System) is 125 mm (option: 150 mm).

Adjustments are made manually or automatically.

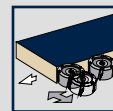

Diamond (DIA) tool

- Tool diameter 125 mm (option: 150 mm)
- Long service life
- Fixed configuration blades and alternative alternating blades are available

1 Fixed configuration blades

2 Alternating blades

Gluing units | Safe hot-melt glue application

HOMAG gluing units are ideal for quick, solid gluing. The standard is an EVA melting unit. The heated gluing roller ensures an optimal adhesive temperature. The magazine height adjustment enables workpieces of different thicknesses

to be processed with one edge height. On request, the gluing unit can also be equipped with a further melting unit for you — for a quick change between two different colors or to PUR.

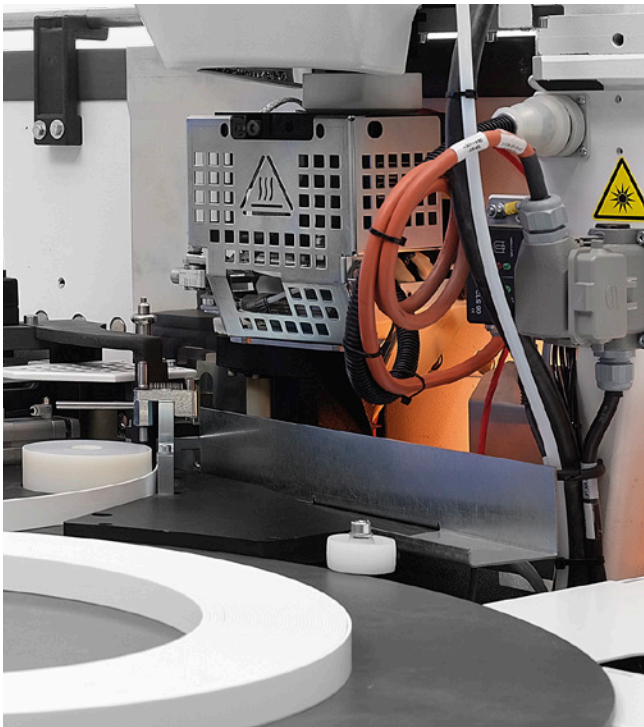

YOUR BENEFITS AT A GLANCE

- Short heat-up time thanks to sensor-controlled level regulation (two levels can be selected)
- The application unit can be easily removed thanks to the quick-release lock
- Melting unit for melting hot-melt glue automatically or manually as required
- Gluing roller with integrated heating unit guarantees a constant temperature and viscosity for all workpiece thicknesses
- Electro-pneumatic clamping of the gluing roller and tank prevents glue contamination on the rear edge of the workpiece
- Tracing pad prevents wear to the application roller and ensures a constant glue film thickness
- Gluing roller lifts when feed stops
- Emptying of the glue in the machine
- The metering slide closes in the event of a power failure
- Automatic cleaning cycle for the metering slide
- QA65 P universally coated application unit for PUR and EVA
- Universal melting unit with interchangeable tanks for EVA and PUR

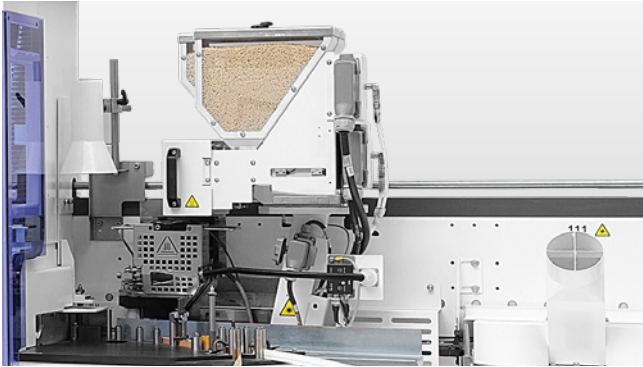

AG12 Basic hot-melt glue gluing station

- For processing rolls of material from 0.3–3 mm. Granulate container for storing and pre-melting hot-melt glue granulate.
- The handling of the application unit when changing the glue and color has been simplified and now offers the option of emptying the application unit in the machine.
- Pneumatic cleaning of the glue roller and the automatic closure of the metering slide in the event of a power failure are also standard.
- An extraction hood—for both EVA and PUR processing—specifically extracts glue vapors.
- Edge heights of 12–65 mm can be processed on all gluing units in the standard version.
- Single strips up to 12 mm thick can be processed in the standard version.

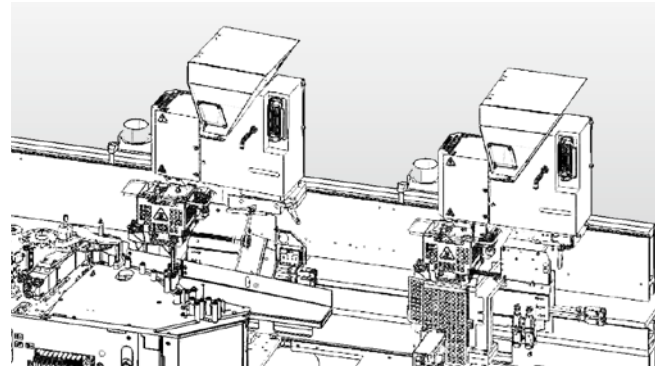

The second (upstream) gluing station

A second gluing station can be set up for automatic changes between hot-melt glue and PUR or between two glue colors without any manual intervention.

For the second gluing station, you can choose between the EVA melting units with a capacity of 6–12 kg/h and 18–35 kg/h.

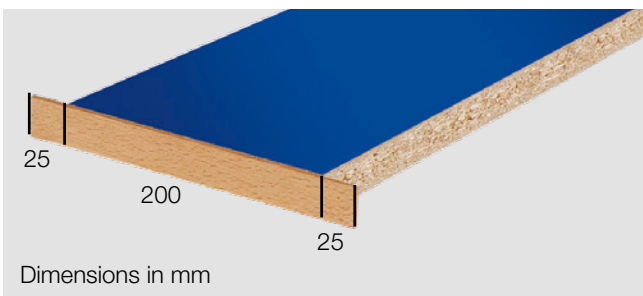

Previous gluing technology

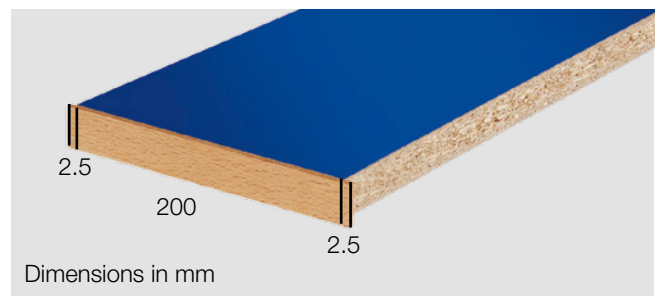

Optimized gluing technology with servo edge feed

Edge feed with a front and rear edge accuracy of +/- 2–3 mm to reduce edge waste.

PUR glue and HOMAG | A strong connection

Using polyurethane (PUR) hot-melt glue increases the resistance of furniture to moisture and heat. It is ideal for use on furniture in damp areas such as bathrooms, kitchens and laboratories.



YOUR HOMAG PUR BENEFITS AT A GLANCE

- One application unit for all types of adhesive
- No additional application unit required
- Fast, powerful thin-film application using a gluing roller with integrated heating unit



Melting unit for PUR

- Melting capacity up to 4 kg/h
- Temperature regulation to protect against overheating



Melting unit for PUR

- Melting capacity up to 6 kg/h
- Temperature regulation to protect against overheating



Melting unit for PUR as base unit

- In different designs and combinations



Combination of melting units for optional processing of EVA and PUR

- Melting capacity up to 12 kg/h for EVA
- Melting capacity up to 6 kg/h for PUR



Service station

- XES200 preheating/service station for the QA65 application unit with one storage position
- High flexibility thanks to up to two vacuum containers for one QA65 application unit or one interchangeable container for a PUR melting unit with up to 4 kg/h capacity
- No vacuum pump and no nitrogen necessary
- With optional accessories also for application units for the powerEdge Pro/Pro Duo CNC edge banding unit



Vacuum container

- Compact, portable container for the PUR application unit
- No vacuum pump and no nitrogen necessary

airTec |

An ideal introduction to zero joint technology

The airTec process has established itself as the optimum zero joint solution for woodworking shops and medium-sized companies. HOMAG's response to increases in demand is an innovative and efficient airTec solution that ensures a more cost-effective use of resources. At the core of the airTec unit

is a rotating fan heater, which, in addition to a high level of efficiency, provides a significantly reduced noise output. All laser-compatible edging types that are currently available on the market can be processed with airTec. This means great flexibility for all materials and colors.



Gluing edges "without joints"

In the airTec process, the edge and panel are bonded using hot air. This requires the use of special edges. These consist of a decorative layer and a functional layer. Using the HOMAG airTec unit, the functional layer is melted at a constant temperature and volume outflow and optimally applied to the narrow surface.

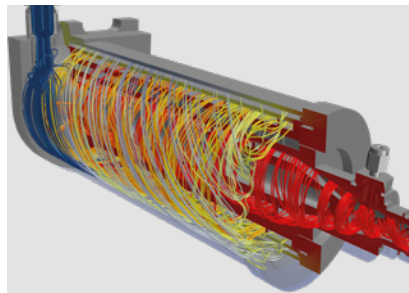

Innovative rotation fan heater

This source of energy heats the air and simultaneously serves as a heat storage that can then be used to heat the air again. In addition, less air is required and the heating effect on the surrounding area is minimized. Any noise is almost exclusively produced during the activation process and is below the noise level of other processing units.

THE BENEFITS

- Reduced noise
- Increased efficiency and more resource-efficient
- Even air flow for high quality
- Rapid changeover between airTec and traditional gluing technology
- Simple operation with the powerTouch control system

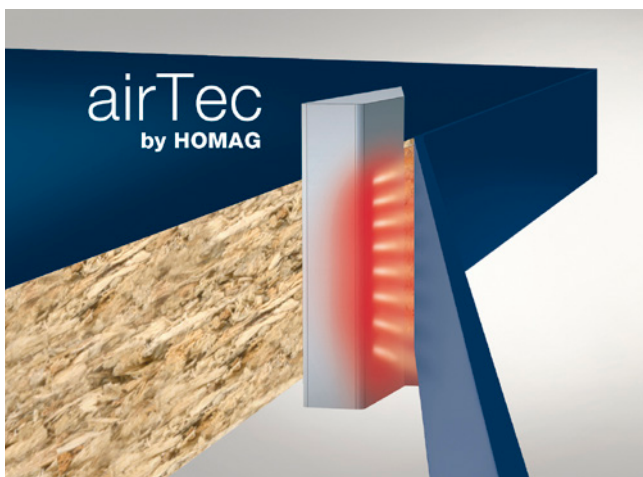

Flexibility for gluing

The EDGETEQ S-500 offers three gluing processes with automatic alternation. As well as airTec, both EVA and PUR can be used on one machine. The respective process can be selected according to requirements. The change from airTec to EVA or airTec to PUR takes place automatically without any manual intervention.

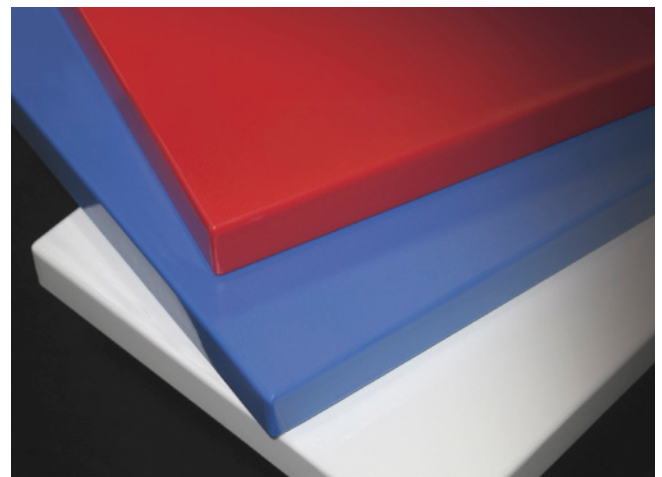

airTec in shift operation

The airTec unit can also be used for continuous operation.



laserTec on the EDGETEQ S-500 profiLine | Zero joint technology for high feed speeds

HOMAG laserTec is the name of the zero-joint technology that has fundamentally changed furniture production. This technique uses a laser beam to melt the surface that is to be

glued, which is then pressed directly onto the workpiece. This results in edges of the very highest quality.

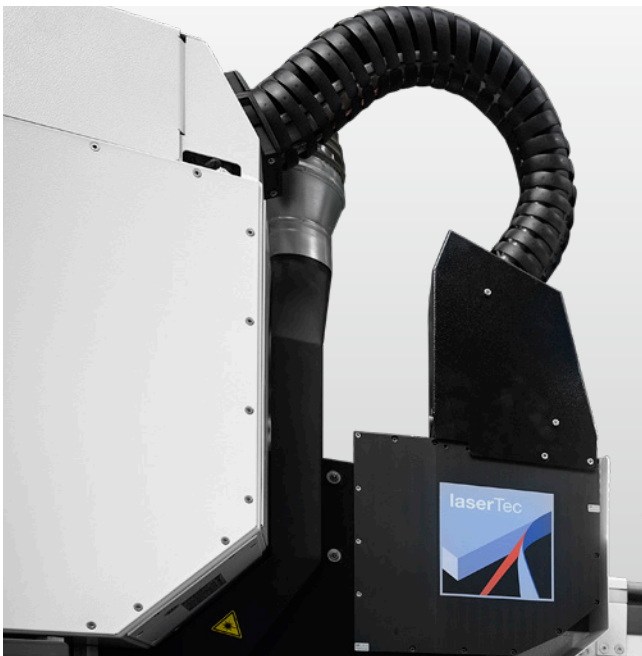

For the entire laser edge range

On the EDGETEQ S-500 profiLine, HOMAG laserTec can be used to process all standard edge types such as PVC, ABS, PP or PMMA. The laser-active layer can be individually adjusted to meet product and customer requirements.

HIGH ECONOMIC EFFICIENCY THANKS TO

- Simple operating processes
- Low additional costs
- High availability
- Reproducible production parameters
- Resource-saving production
- Maximum production safety
- Use at high feed speeds and for large workpieces

Systematic gluing

For solid gluing, it is crucial to achieve an optimum interplay of very different factors. On HOMAG machines, the workpiece preheating, application unit, quick-release system, melting

unit, magazine, and pressure zone are perfectly aligned. The automatic glue quantity metering leads to even higher performance and cost efficiency.



Automatic glue change:

An additional application unit can be used to switch between two types of glue or two colors.



Automatic glue quantity metering

The quantities of adhesive are implemented quickly and easily via the powerTouch2 user interface.



Interchangeable container for EVA and PUR

For a quick glue change via the universal melting unit.



Workpiece preheating

High-strength gluing due to optimum workpiece preheating.



Insertion of wide solid strips

Wide, high-capacity magazine for fixed lengths and optimum access for filling.

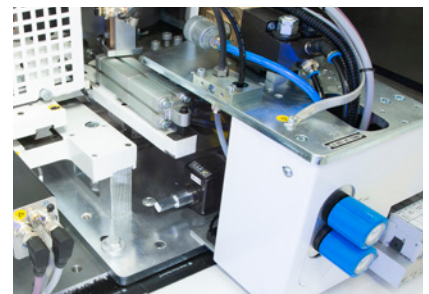

Magazine height adjustment

For processing rolls of materials from 0.3–3 mm and solid wood strips up to 12 mm (20 mm). Different workpiece thicknesses can be run with one edge height.

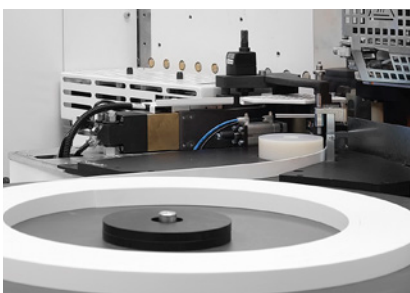

Magazine with one roller (manual)

One edge feed and one horizontal roller mounting. Edge feed via servo drive to reduce edge waste.

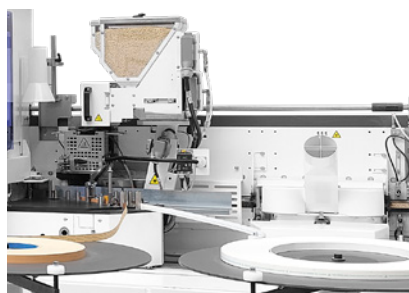

Magazine with two rollers (automatic)

Two edge feeds and two roller mountings for automatic switching between two edges.



Magazine with six rollers

Automatic feed of six different edges.

Snipping units | For cutting the overhangs on the front sides

The snipping units perfectly prepare the workpieces for subsequent trimming. The front side can be snipped straight or with a chamfer.

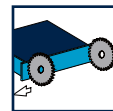
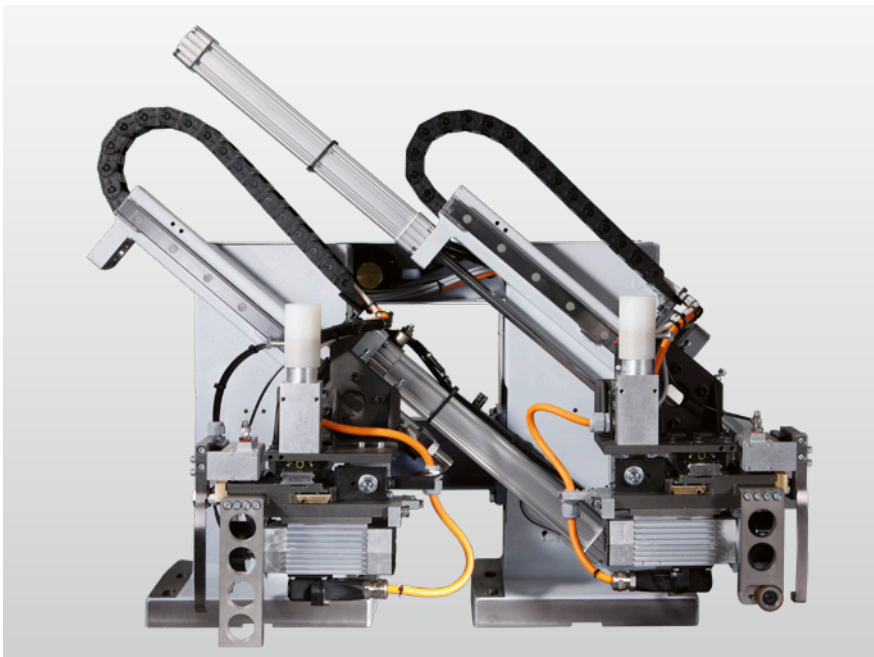

HL81 snipping unit

For snipping edge overhangs on the front and rear edge of the workpiece with a drawing cut for clean snipping cuts.

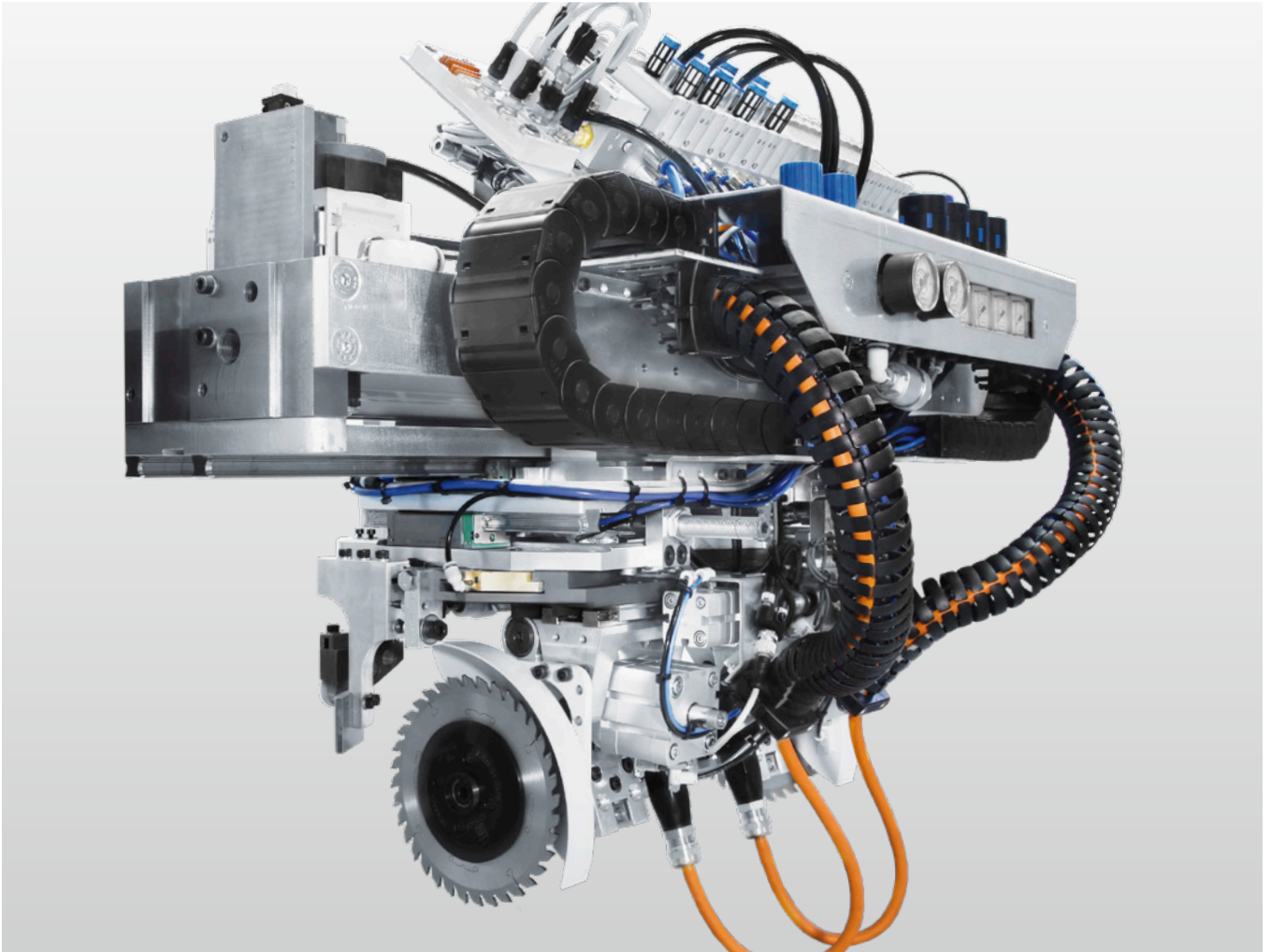

PK25 snipping unit

For snipping edge overhangs on the front and rear edge of the workpiece with a stationary snipping stop.

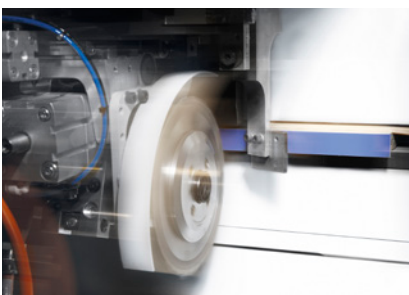

PK25 snipping unit

Feed speed up to max. 25 m/min.

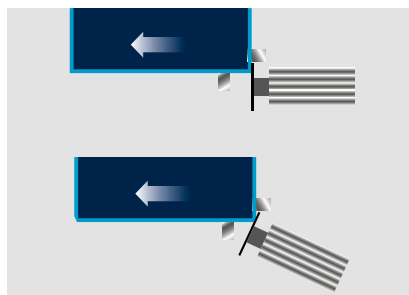

Automation in the standard version

Programmable adjustment of the snipping motor for chamfers/straight lines, for a quick change between straight-line snipping and cutting with a chamfer.

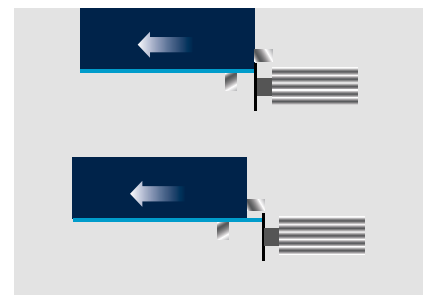

Can be automated

For a quick change between flush snipping, e.g. of solid strips or shelves, and cutting with an overhang, e.g. for post-trimming cutting with a profile trimming unit.

Trimming units | For flush trimming

The pre-trimming and fine trimming units offer the perfect solutions for processing edge overhangs. The trimming units are only equipped with tools that collect the chips in a

controlled manner. This and the HSK interface patented by HOMAG ensure high processing quality and long tool life.

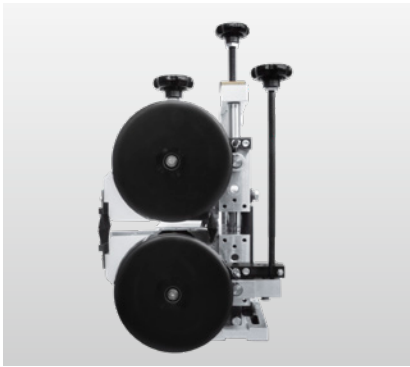

Pre-trimming unit

For pre-trimming top and bottom edge overhangs.

Can be automated

Automatic change from flush trimming to trimming with an edge overhang with two-point adjustment.



PF20 fine-trimming unit

For trimming chamfers and radii with optimized chip extraction and manual adjustment.

Can be automated

Automatically change between two radii and a chamfer with a PF21 unit.



MF21 multi-trimming unit

Automatically change between 3 radii and a chamfer.

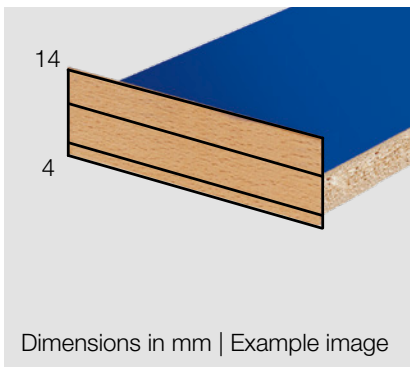

BF10/BF20 pre-trimming unit

Larger overhangs are possible via breakout of the pre-punched perforation on the extraction hood.

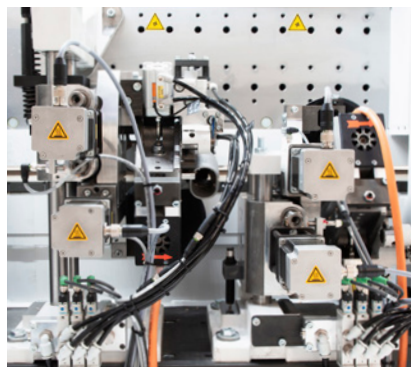

BF40/MS40 trimming unit

Fully automatic changeover from one or two different profiles and flat level through the use of servo motors.



- 1 Flat: MS40**
- 2 Profile 1: MS40**
- 3 Profile 2: MS40**

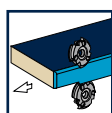
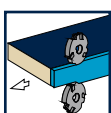



Profile trimming units | For corner rounding

HOMAG profile trimming units trim around the front and rear edges of the workpiece. Important adjustments are made via program selection in the control system.

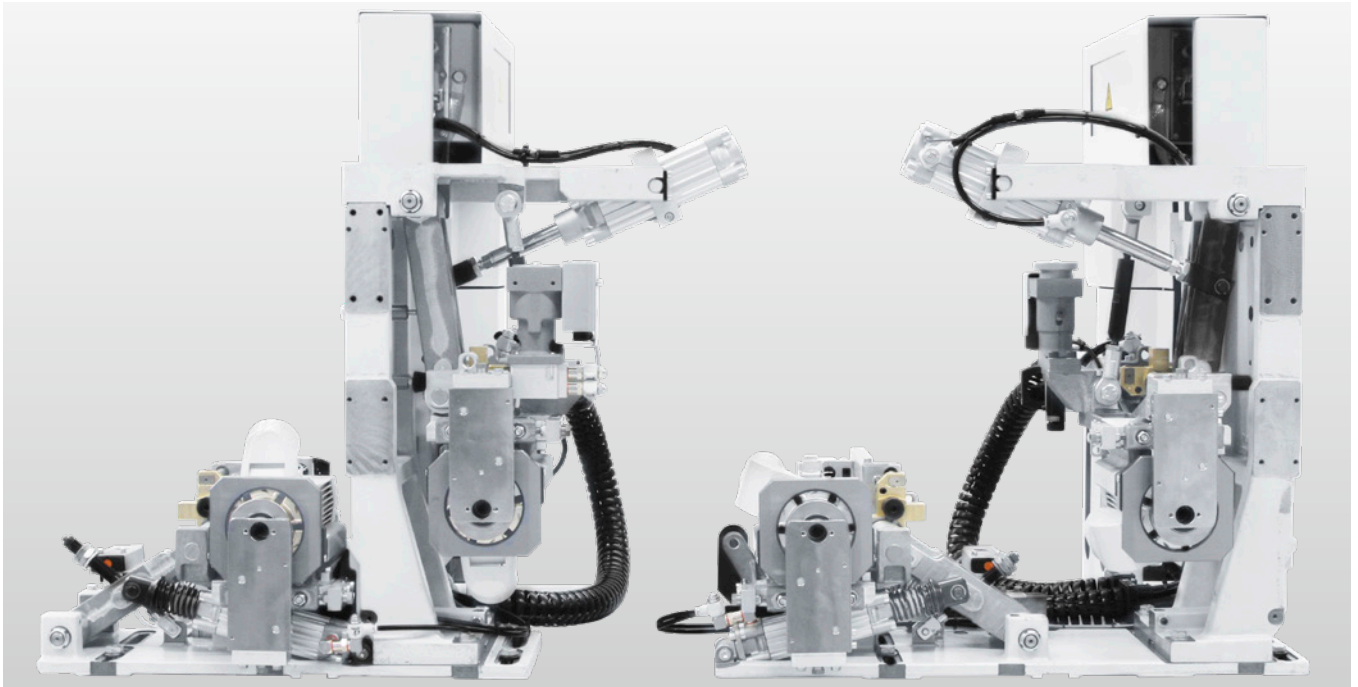

FF32 profile trimming unit

As the cut is spread over four motors, each corner can be processed in synchronous rotation. This gives you perfect trimming quality for all types of edges — even for veneers. Workpiece thicknesses and feed speeds are adjusted automatically without manual intervention.

Can be automated

Infinitely variable chamfer/radius adjustment for fast processing changes, for example from a 0.4-mm edge to a 2-mm edge.

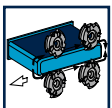

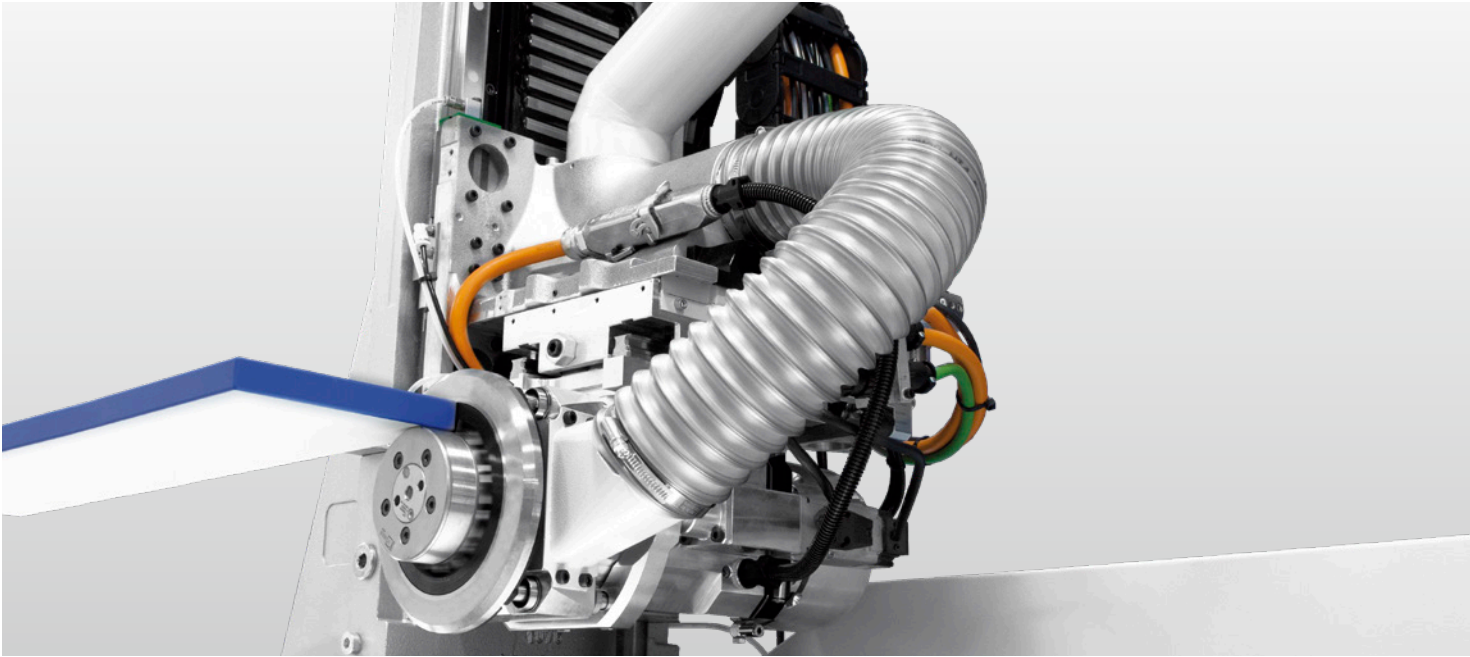

MF60 Servotrim multifunction profile trimming unit

The motion sequence is servo-controlled with a Soft Touch function, for optimum processing of high-gloss surfaces or lightweight panels, for example.

Can be automated

Adjustment to two different radii as well as automatic adjustment of the detector rollers.

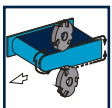

FK30 profile trimming unit

The motion sequence is performed with linear motors. The high accelerations of the linear motors when rounding the edge enable the best-possible processing quality.

Can be automated

Adjustment to two or three different radii as well as automatic adjustment of the detector roller diameter.

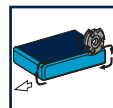

Finishing units | Optimally aligned with one another

Our perfectly coordinated finishing units enhance the quality of your products.

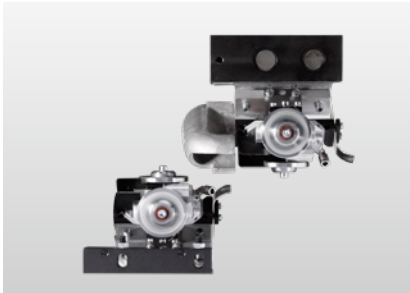

PN10 profile scraper

For smoothing trimmed edges for an optimal look.

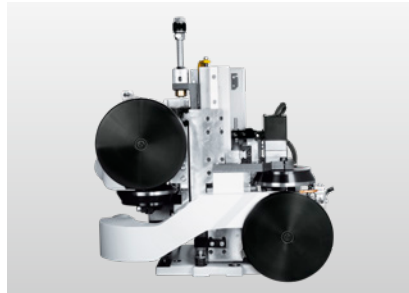

MN21 multi-scraper

For smoothing trimmed edges for an optimal look. Automatic changeover between a maximum of seven different profiles, corrections in the range of a hundredth of a millimeter. Reproducible quality at the highest level.

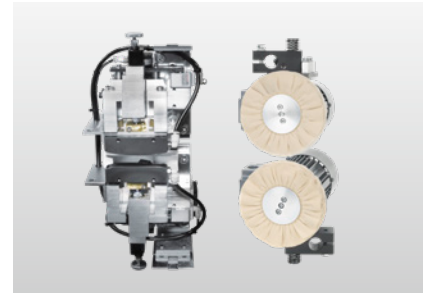

Finishing

Consisting of a glue joint scraper for removing glue residue at the top and bottom on plastic edges, and a buffing unit.

Can be automated

Move out of the working area.

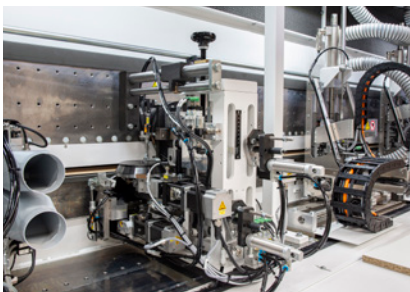

MN11 profile scraper

For smoothing trimmed edges for an optimal look. Automatic changeover between two profiles. Fine corrections for reproducible quality at the highest level.

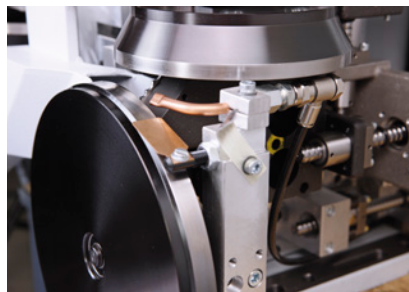

Automation

Automatic changeover between different profiles, corrections in the range of a hundredth of a millimeter. Reproducible quality at the highest level.

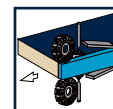
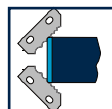
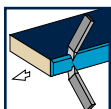



Anything but standard

We offer a wide range of solutions for processing workpieces to expand the range of functions of the machines according to your individual requirements.

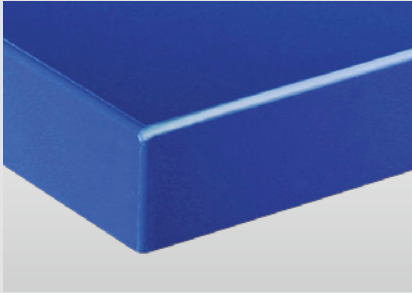

Workpieces with protective film/high-gloss

For perfect high-gloss parts, important components such as the motorized top roll pressure element and the automatic adjustment of the glue joint scraper come into play.

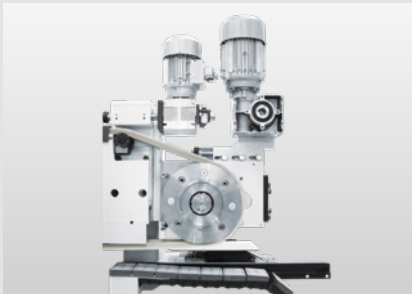

Motorized top roll pressure element



Automatic adjustment of the glue joint scraper

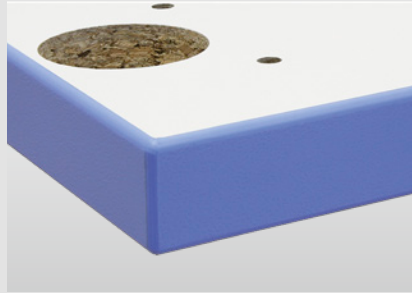

Workpieces with hinge holes (nesting method) or pointed/blunt-angled parts

Depending on the unit configuration, different tracing elements are installed. They are ideal for processing parts with hinge holes, such as those produced in nesting, as well as pointed or blunt-angled parts.



Tracing elements for hinge holes

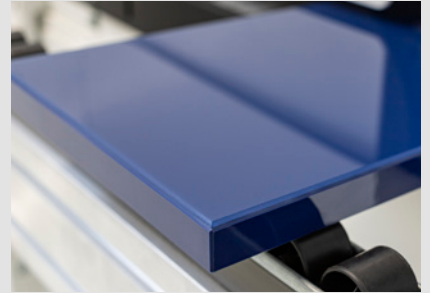

Glass laminate with 45° chamfer

To process glass laminate, HOMAG uses stable, robust units such as the multi-trimming unit and the multi-scraper blade with special tools.



MF21 multi-trimming unit

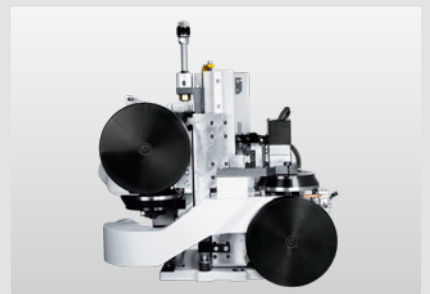

MN21 multi-scraper



Structural shelves

Profile trimming is also possible on workpiece sides without an edge. This applies not only to structural shelves, but also to upper and lower shelves, shelf inserts and partition panels.



Processing of workpiece thicknesses up to 100 mm

By expanding the joint trimming unit, the PK/SK snipping units and using special equipment for the application unit and the FK30/FK31 profile trimming units, workpieces of 100 mm can be processed in perfect quality.



Doweling parts

Finished doweled parts can be edged later, even if dowels are protruding on the transverse edge. A recessed snipping stop ensures perfect processing results despite the presence of dowels.



Small parts processing

Optimum workpiece guidance and processing is also provided for workpiece lengths < 240 mm to a minimum length of 120 mm (in the throughfeed direction). The narrow roller pitch at the top roll pressure element provides greater flexibility in the production range.

Standard trimming unit for grooving | Processing in one throughfeed

For efficient production of your workpieces in one throughfeed without any additional process steps.

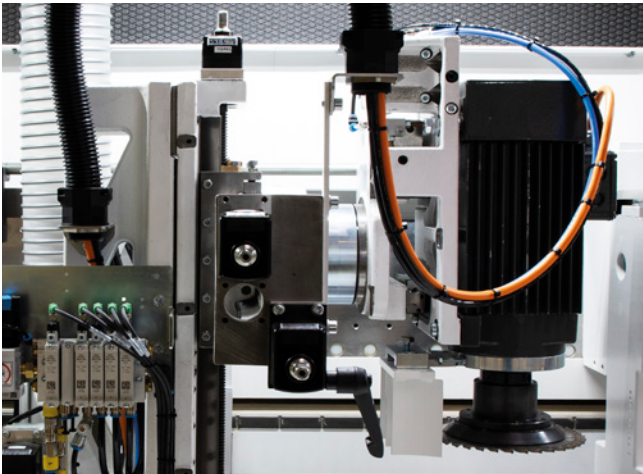

SF21 standard trimming unit

Grooving, rabbet trimming and profiling within the machine without any additional processing step.

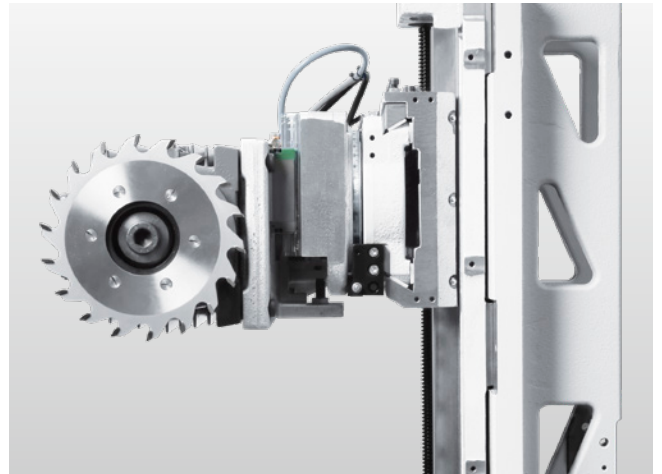

Can be automated

Adjustments are made via automatic axes or in the workpiece gap via servo drives.

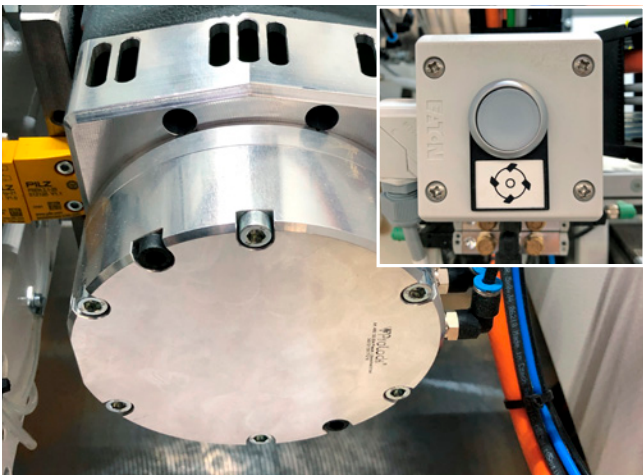

HSK pushbutton

Fast manual tool change for different groove widths.

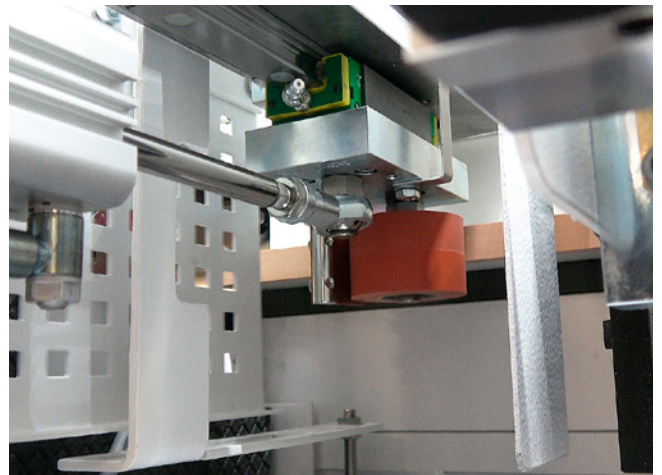

Safety equipment

For grooving in solid strips in synchronous rotation.

Belt sanding units on the EDGETEQ S-500 profiLine | Always in the best shape

Whether straight edges, chamfers or radii for veneers: leave them to the HOMAG belt sanding units — the KS10 belt sanding unit or the PS41/PS42 chamfer/radius sanding units.

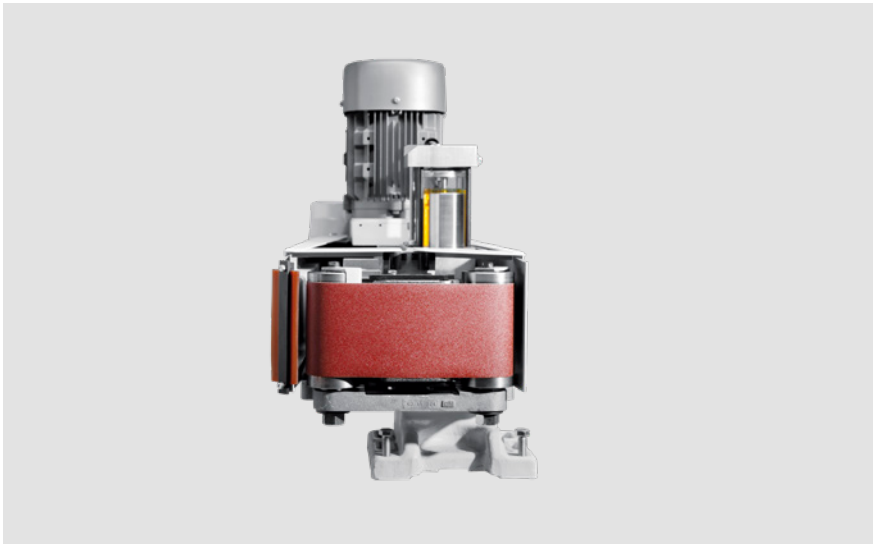

KS10 belt sanding unit

For sanding straight veneer edges, including oscillation in the standard version.

Can be automated

For moving out of the working area and infinitely variable adjustment to different edge thicknesses.

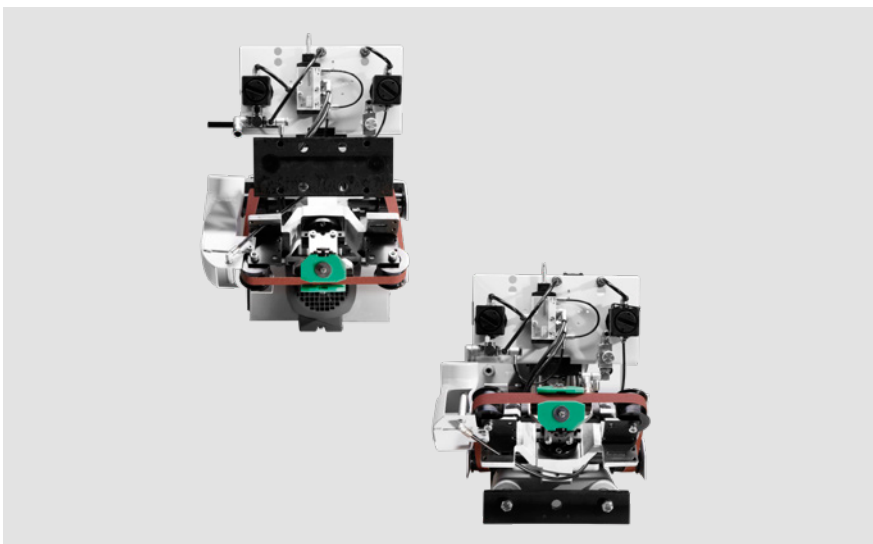
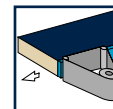

PS41 and PS42 chamfer and radius sanding unit

For sanding chamfers and radii at the bottom/top of veneer edges.

Can be automated

For moving out of the working area and infinitely variable adjustment to different edge thicknesses.

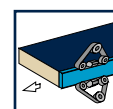

Two-profile technology | Automatic and accurate changeover

HOMAG two-profile technology can be used to automatically change between two profiles and a chamfer. The axis adjustments allow a short setup time with perfect repeat accuracy.

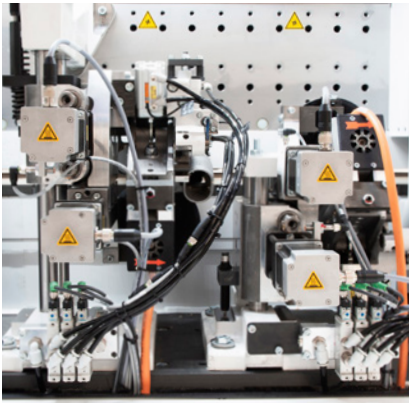

MS40 multi-level trimming unit

Fully automatic changeover to two different profiles and flat level using servo motors.

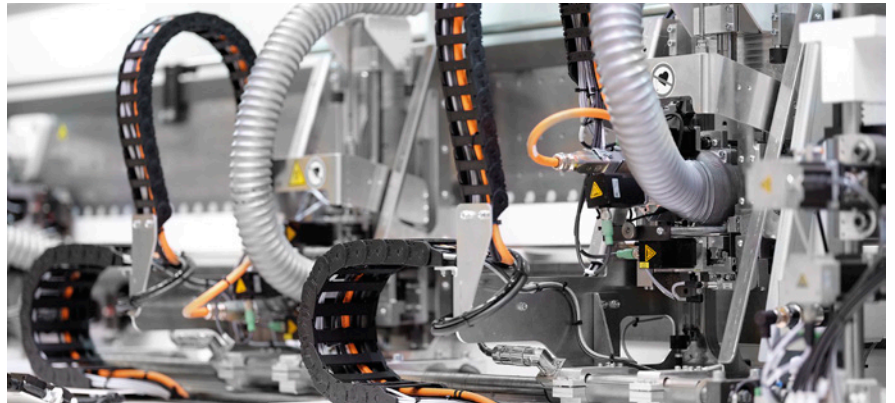

MF60 Servotrim multifunction profile trimming unit

For processing edge overhangs on the upper and bottom edge of the workpiece and for corner rounding of the front and rear edge.

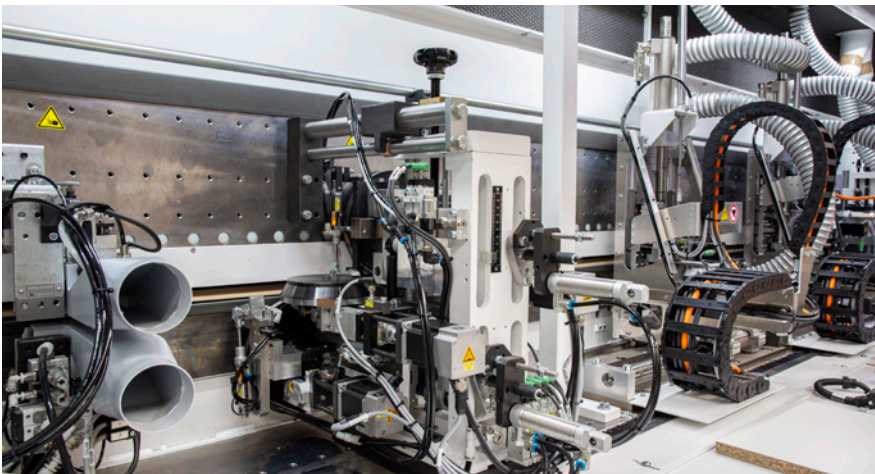

MN11 multi-scraper

For smoothing trimmed edges for an optimal look.

Three-profile technology |

Shorten setup times and achieve perfect results

HOMAG three-profile technology can be used to automatically change between three profiles and a chamfer. In addition to short set-up times, you can achieve reproducible quality at the highest level.



MF21 multi-trimming unit
For profile trimming the edge.

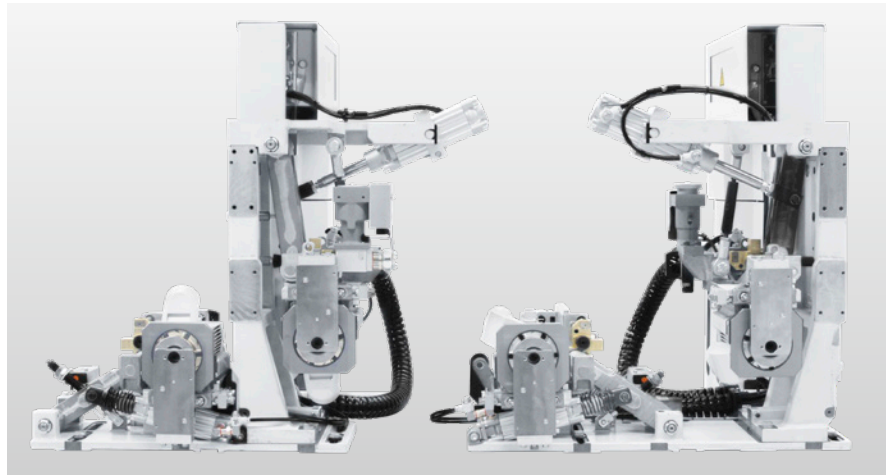

FF32 profile trimming unit
For rounding edges on the front and rear edge of the workpiece at the top and bottom at different feed speeds.

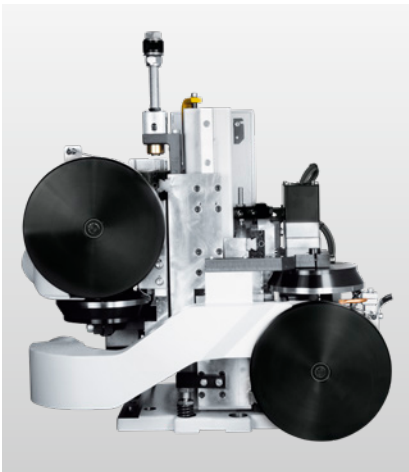

MN21 multi-scraper
For smoothing trimmed edges for an optimal look.

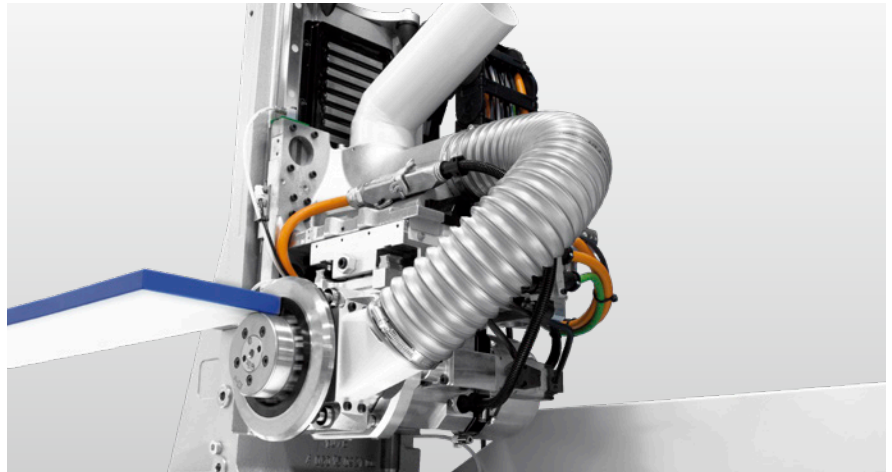

FK30 profile trimming unit
For trimming around the front and rear edges.

Apps and digital assistants.

Quick and easy support in your machine environment.

Some people still use pen and paper to create their cutting patterns. But they look at their smartphone if they want to know what the weather is like – instead of looking out of the window. We asked ourselves: why not combine the best of both? Our apps and digital solutions make your everyday work easier: machines, material, tools, cutting patterns, components – you always have everything in your pocket or on your desk.

EXCERPTS FROM YOUR FEEDBACK:

- Are there simple solutions that can eliminate various obstacles in my day-to-day work (e.g. when organizing materials or sorting parts)?
- Is there a way to slowly approach using digital assistants?
- Which tools can you try out simply and easily without having to invest huge sums of money straight away?

OUR ANSWER? SMART AND POWERFUL SOLUTIONS:

- ✓ Always low investment
- ✓ Always up to date (no updates necessary)
- ✓ Always easy to use (no complex software)
- ✓ Always helpful

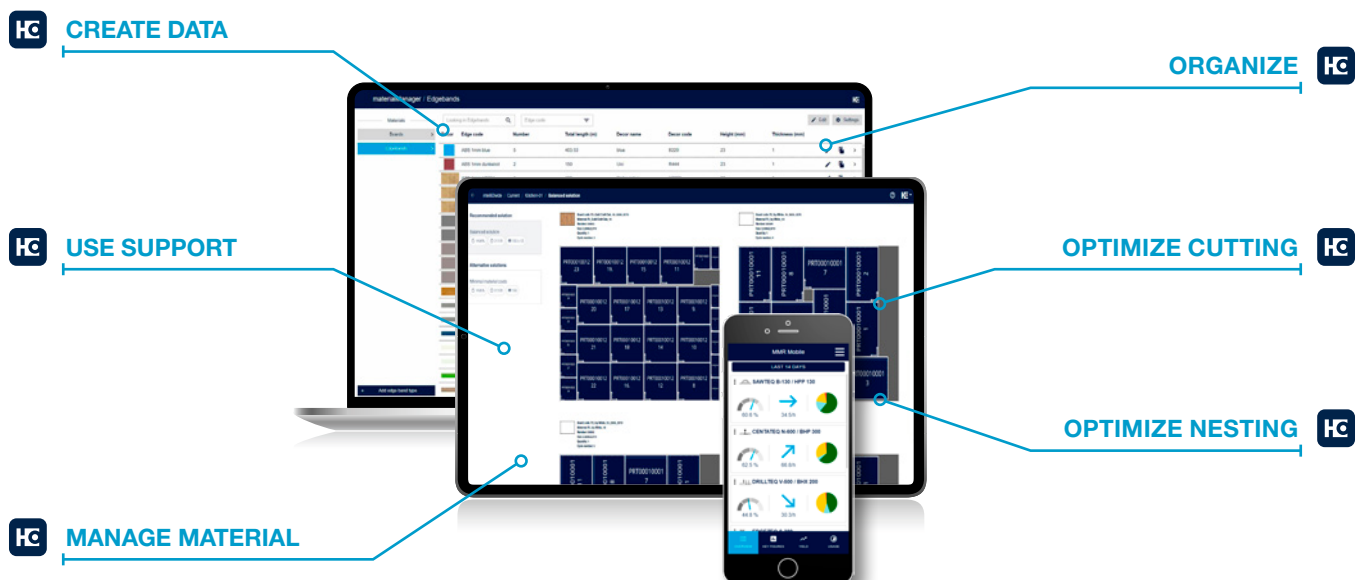



THE ADVANTAGES AT A GLANCE

- No investment, update or maintenance costs
Low starting price, no unplanned financial expense
- Licenses are independent of the user
Any number of employees can use the application without incurring additional costs
- Independent of hardware and operating system
Can be used anywhere, anytime
- Open system – import possible from almost all systems (ERP, industry software, CAD/CAM, Excel, CSV)
No obligation to use specific software systems
- Simple, smart operation
Minimal training required
- More efficient production
Jobs completed more quickly, more safely and in higher quality



More information at
digital.homag.com

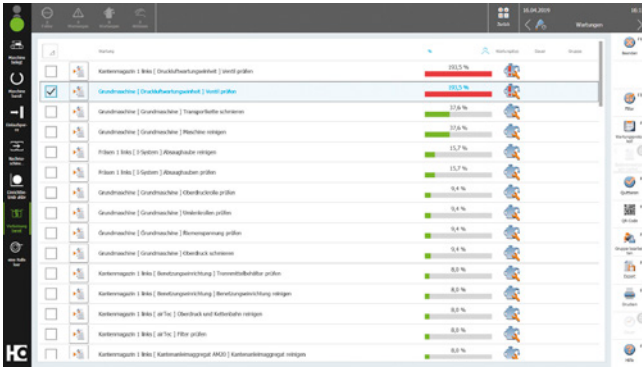

Evaluation with MMR Basic

The software evaluates the productivity of your machine and provides maintenance instructions based on use.

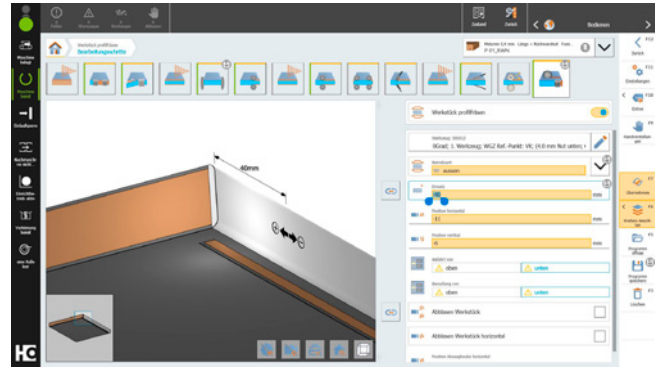

NEW: Programming with woodCommander 5

User-friendly programming system through graphically supported input screens on individual machines.

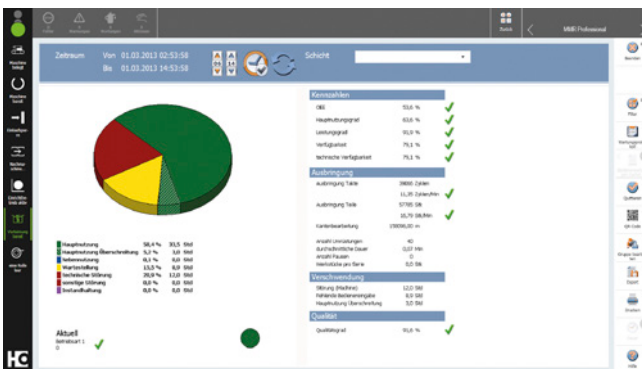

MMR Professional

The extension to MMR Basic also evaluates shifts, analyzes error messages, and allows you to connect to central data evaluation in the office.

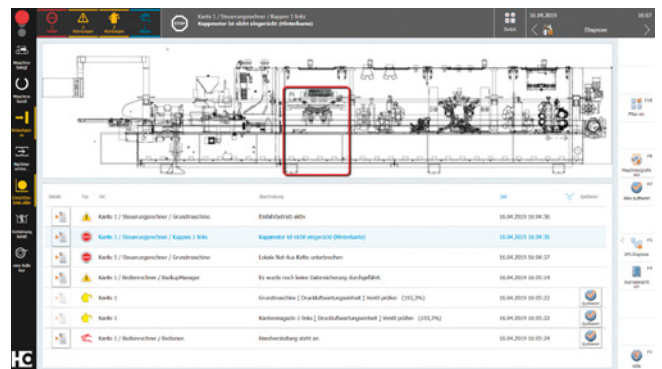

woodScout diagnostic system

In addition to plain text error messages, woodScout displays the location of the malfunction on the machine graphically. In addition to the expert knowledge of the system, you can store your own measures for troubleshooting.

The next generation of powerTouch: **powerTouch2**

Faster, more comfortable, clearer: Enjoy the benefits of our further improved powerTouch user interface. We have optimized our standardized operating concept and further adapted it to our customers' requirements. Controlling your HOMAG machines is now even faster and more intuitive. The new, modern design has a clear structure. The innovative touch operation allows you to achieve the desired result easily and comfortably.

With the new powerTouch generation, you can enter information at your machine even more quickly. Compared to the previous version, you can achieve a time saving of up to 30%. This is possible thanks to new features, such as automatic word completion, a pop-up keyboard that can be kept open and Windows-like functions, such as the selection of common actions directly via the start button.

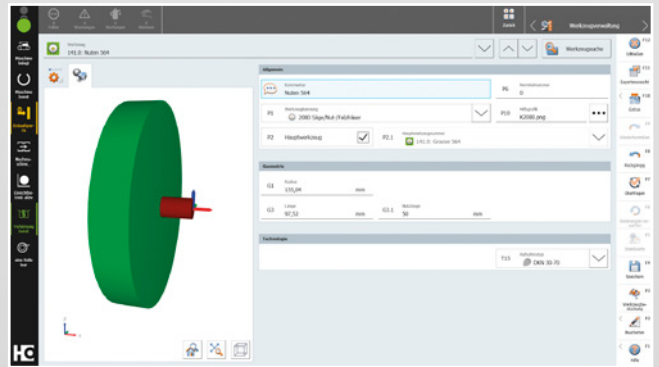

THE HIGHLIGHTS AT A GLANCE:

- Direct and efficient operation, up to 30% faster
- Clearer and more informative thanks to additional information and live illustrations instead of program icons
- New applications for operating and controlling machines and systems (e.g. NCCenter in the PC87 control system on CNC machines or woodCommander 5 on throughfeed machines)
- Fresh, attractive design, based on the new HOMAG machine design





Higher productivity for your edge banding machine

The LOOPTEQ series workpiece returns are an optimal addition to machines from the EDGETEQ series. The LOOPTEQ O-200 is ideal for small, narrow and medium-sized workpieces. The LOOPTEQ O-300 is ideal if you have a wide range of parts, from small and light to large and heavy workpieces. The high degree of automation makes the LOOPTEQ O-600 with workpiece handling a true all-rounder.

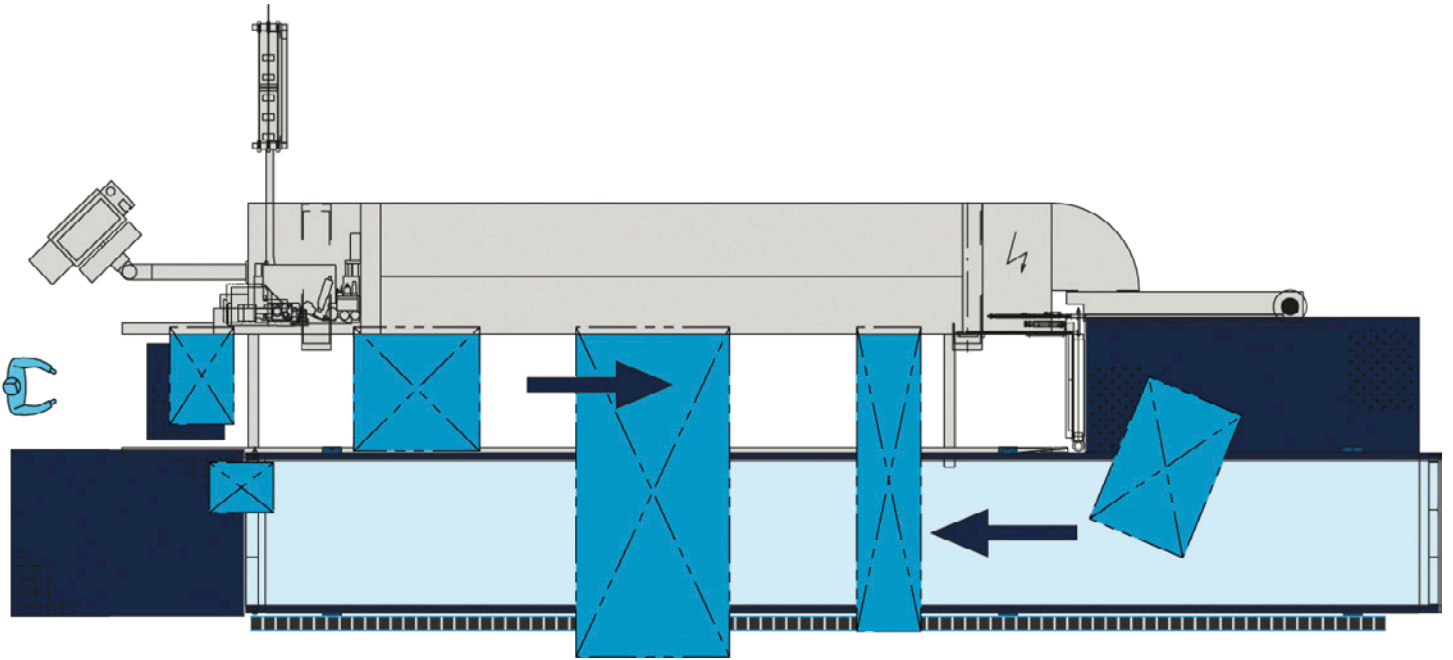

EDGETEQ S-500 with workpiece return LOOPTEQ

LOOPTEQ O-200 and LOOPTEQ O-300 return: Higher productivity for your edge banding machine

This indispensable helper makes the return system of your HOMAG EDGETEQ even more efficient. Single-person operation enables you to optimize your workpiece return flow, resulting in a streamlined and efficient production process.

Your HOMAG EDGETEQ S-500 series machine can be freely combined with this return. It is ideally suited for customers with small, narrow and medium-sized workpieces.

Your benefits at a glance:

- **Fast return on investment** — pays for itself from just nine hours of operating time per week
- **Flexible personnel organization** — thanks to cost-effective single-person operation
- **Ergonomic working** — manual parts handling is reduced to a minimum
- **Better quality control** — quick response to material adjustments

Technical data

	LOOPTEQ O-200	LOOPTEQ O-300 TFU 140/20	LOOPTEQ O-300 TFU 140/25
Workpiece length (mm)	300–2500	300–2500	240–2700
Workpiece width (mm)	50–1450	60–800	60–1000
Workpiece thickness (mm)	8–60	8–60	8–60
FOUR-SIDED PROCESSING*			
Min. workpiece size (mm)	300 × 300	300 × 80	240 × 80
Max. workpiece size (mm)	1450 × 1450	2000 × 800	2500 × 1000
MISCELLANEOUS			
Max. workpiece weight (kg)	50	50	50
Surface weight (kg/m ²)	25	25	25

*In four-sided processing, larger parts can be returned or ejected with manual assistance in the event of transverse offset or rotation.

By the way

The return pays for itself within one year, starting from nine hours of use per week!

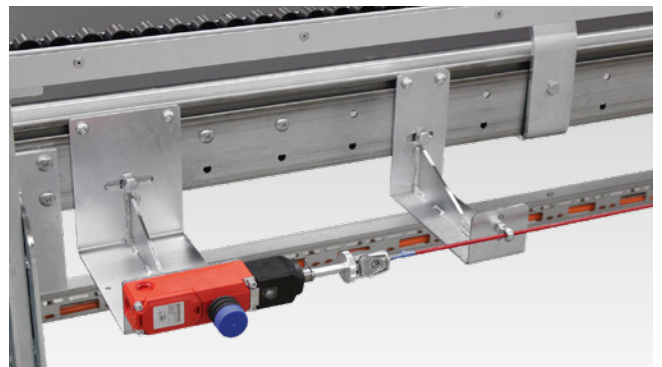

Safety equipment

Pull cord longitudinally to the return belt.



Cleaning the belts

For optimum protection against dust and chips.

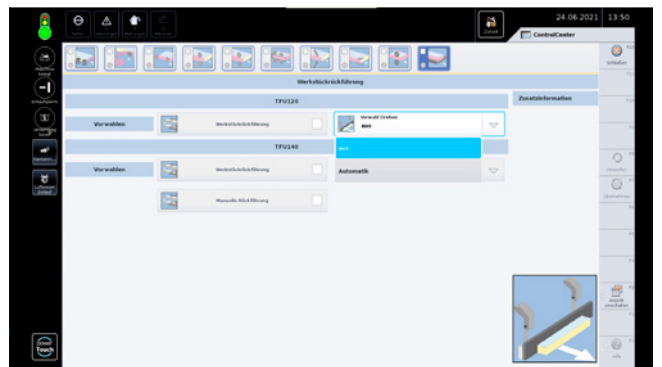

Return control system

The parameters for the operating modes are integrated in powerTouch.





LOOPTEQ O-600

INCREASED FLEXIBILITY IN THE PARTS FLOW

Stacking system and workpiece return combined in a single machine. The high degree of automation makes the LOOPTEQ O-600 workpiece return a true all-rounder. Finished workpieces can be ejected or stacked.

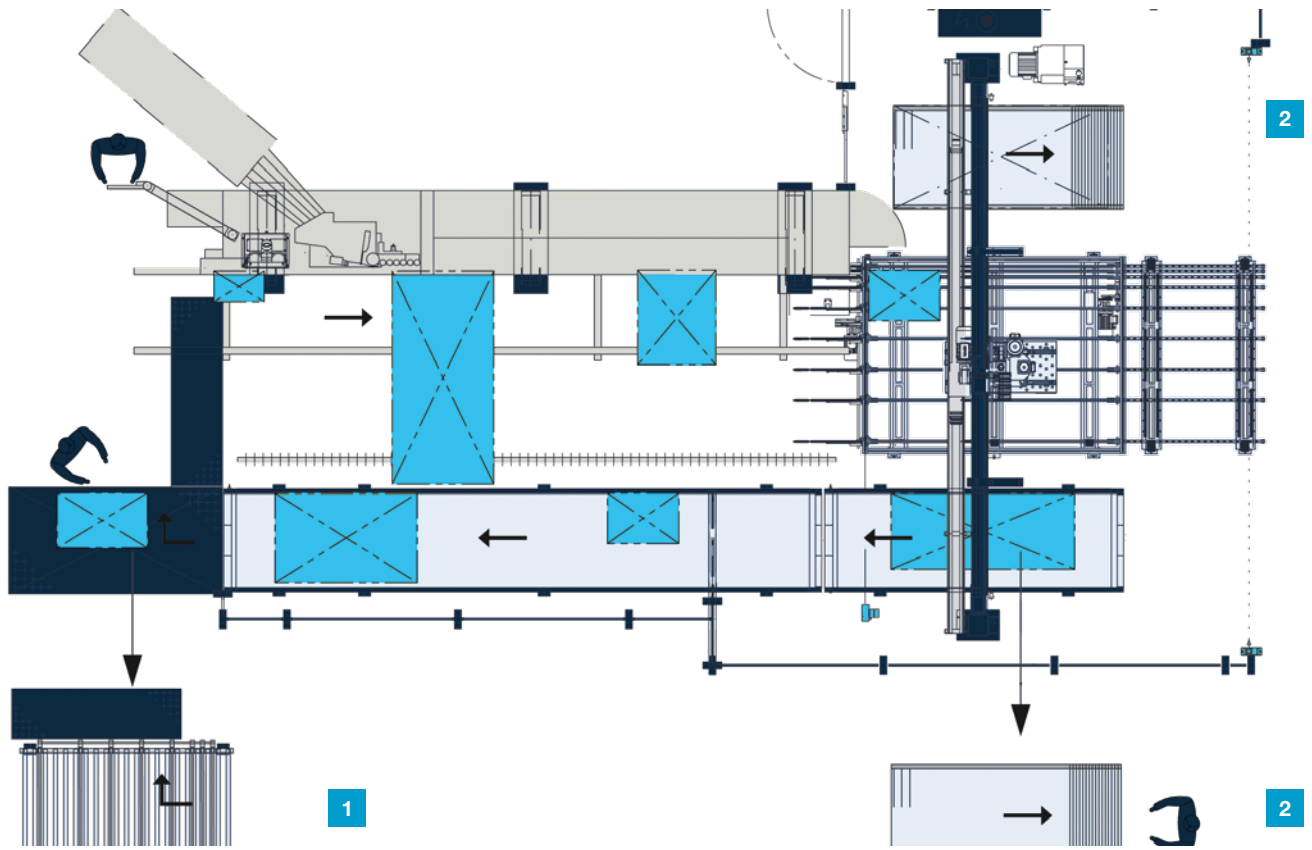

1 Ergonomics package II function — Workpiece turner combined with air cushion table for ergonomic handling of workpieces

2 Removal function — stacking position

Technical data

Workpiece data		
Workpiece length (mm)	240–2500	240–3000
Workpiece width (mm)	80–1200	80–1200
Workpiece size (mm)		
Four-sided processing*		
Min. workpiece size	240 × 120	240 × 120
Max. workpiece size	2500 × 1200	3000 × 1200
Workpiece thickness (mm)	8–60	8–60
Max. workpiece weight (kg)	80	80
Surface weight (max. kg/m²)	25	25
Processing height (mm)	835–950	835–950
Stacking positions	0, 1, 2	0, 1, 2

*In four-sided processing, larger parts can be returned or ejected with manual assistance in the event of transverse offset or rotation.

IDEALLY SUITED FOR CUSTOMERS WITH A LARGE VARIETY OF PARTS AND A PRODUCTION WITH A HIGH DEGREE OF AUTOMATION.

- Minimal quality costs — gentle handling via vacuum cross rail
- Flexible personnel organization — thanks to cost-effective single-person operation
- Ergonomic operation — personnel relieved of heavy physical work
- Smart automation — high-performance interlinked material flow
- Increased efficiency — defined rotation for process-oriented return of parts



Workpiece turner for outfeed
(optional)



Collect workpieces
(optional)



Cleaning the belts
(optional)



Braking brushes for air cushion table
(optional)



Equipment for CE conformity:
Protective grating along the entire return path

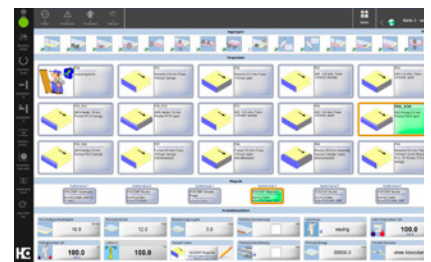

Control system integration:
LOOPTEQ control is integrated into the user interface of the edge banding machine.

Production lines with EDGETEQ S-500 profiLine

The machines in the EDGETEQ S-500 profiLine series are equipped in such a way that two machines can be interlinked as a line. For example, they can be combined with a feed

system and an offset station. Ask about HOMAG basic concepts 1 and 2.

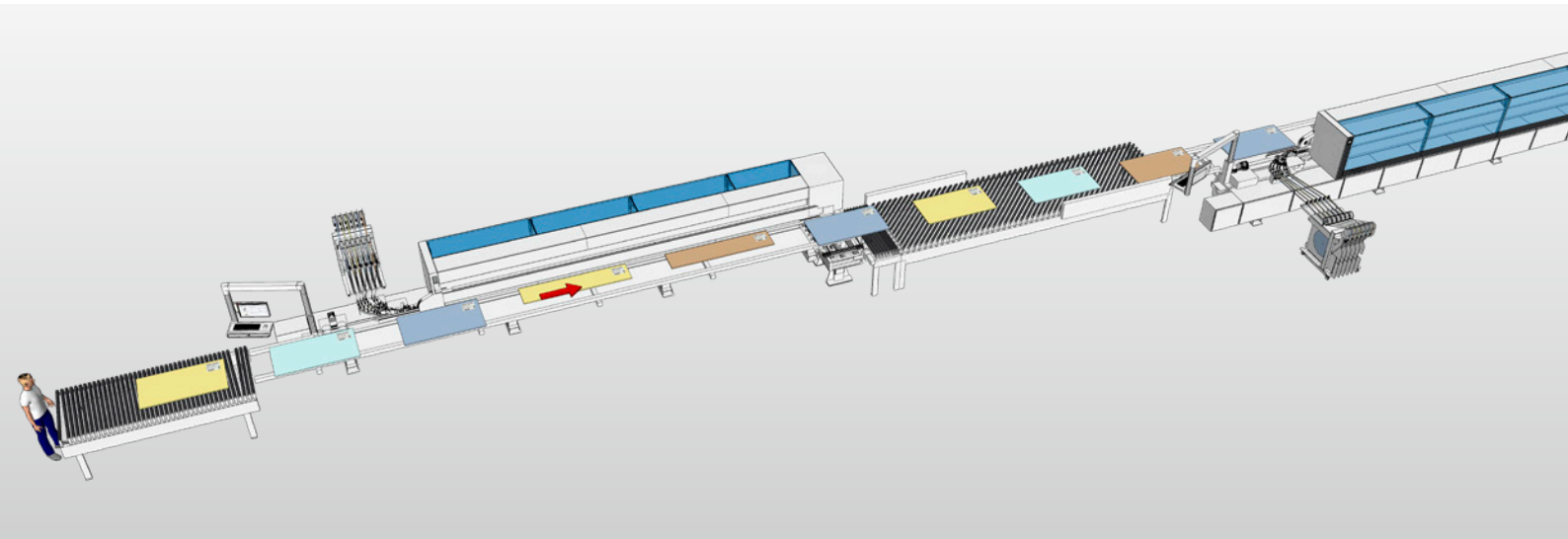

Production line for medium-sized capacities

In this example, the workpieces are processed in two process steps on four sides. The workpieces are transported back in a stack or individually.

woodFlex cell control system

For controlling the production line and to track parts.





VALYOU

Our Mission, Your Performance.

HC LIFE CYCLE SERVICES

Improved performance, more efficient processes, faster help, assurance of availability and smarter workin

TEAM & COVERAGE

Largest global service network in the industry with over 1,350 personnel.

INSTALLATION & COMMISSIONING

For a smooth start, we only let proven experts manage your setup.

OPERATION & CONTROL

After teaching your personnel the intuitive control system, our clever apps help to make the operator's life much easier.

MAINTENANCE & SERVICING

To keep things running, we're happy to take a preventative approach. You decide how often and how intensively you want the support to be. As we all know, prevention is better than the cure.

eSHOP & ONLINE ADVANTAGE

A few clicks and it's fixed. Receive exclusive advantages by ordering spare parts online, depending on market availability. shop.homag.com

HOTLINE & READINESS

When there's an emergency, we're here. Direct by phone, digitally via app or video, or with on-site support. We are close to you with over 90 regional service organizations worldwide. With more than 35,000 spare parts immediately available, we can deliver 85% of your orders fast.

TRAINING & EDUCATION

With classroom, live online or eLearning training, we offer flexible options to help you get knowledge. We conduct over 4,000 customer training courses every year, and we even have our own training centers in 19 countries

MODERNIZATION & IMPROVEMENT

Our modernization program is tailored to your machines and processes. We can evaluate your data and situation and advise you on the next step.

ANALYSIS & SUSTAINABILITY

On request, we analyze all your processes with proven tools and procedures (LeanSixSigma). We have a large, certified team of experts for this purpose.

FINANCING & CONSULTING

We offer you tailor-made financing concepts worldwide. With more than 60 years of experience and a close partner network of prominent banks and insurance companies to help us to find the right solution for you, we're always transparent and reliable in processing.

Fast support:

94% resolution rate
via our hotline

Close to you:

1,350 service experts worldwide

We get things moving:

Over 1,000 worldwide spare parts
shipments each day

No one else has that:

Electronic documentation on over
150,000 machines, available in 28
languages

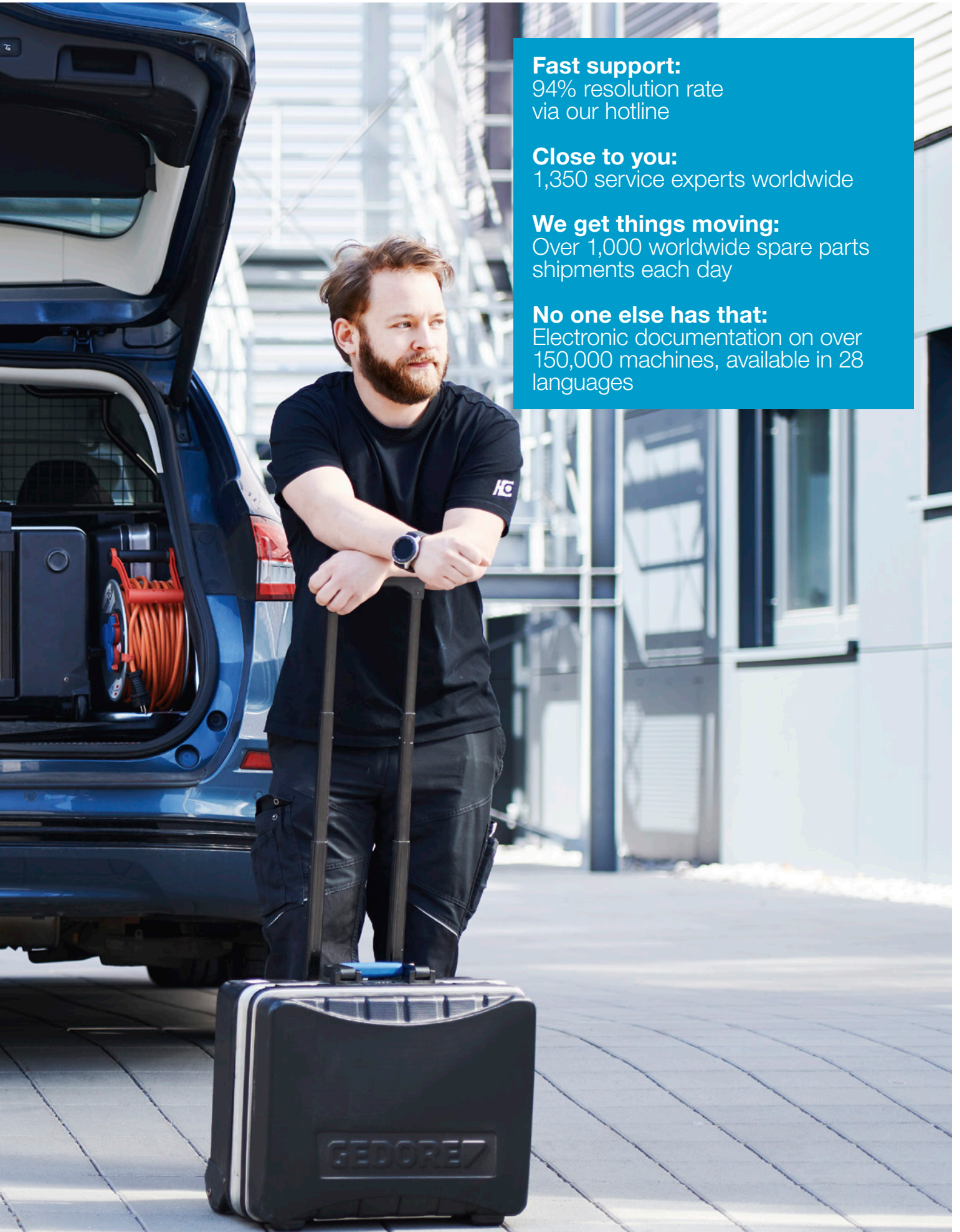



HOMAG Group AG

info@homag.com
www.homag.com

YOUR SOLUTION